

Dorado *gold*

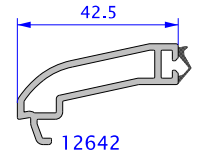

TEKNİK KATALOG

	<u>sayfa no</u>
Sistem Tanıtımı	1.1 – 1.3
Ana Profiller	2.1 – 2.9
Kesitler	3.1 – 3.60

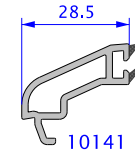
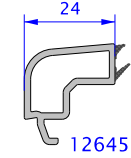
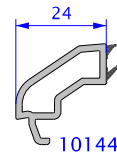
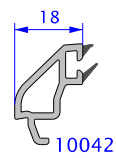
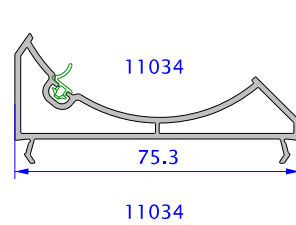
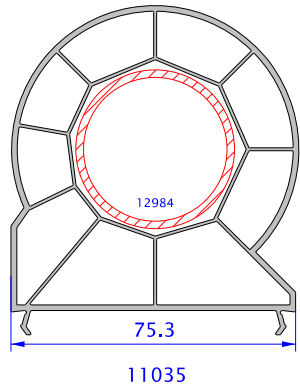
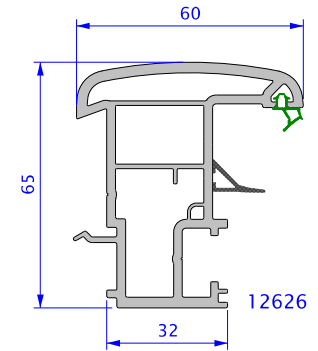
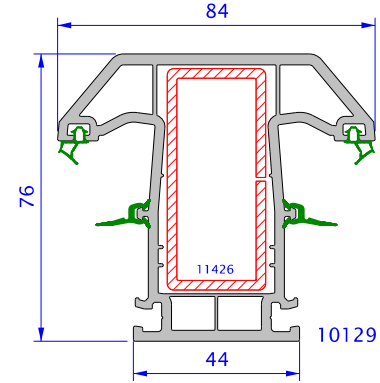
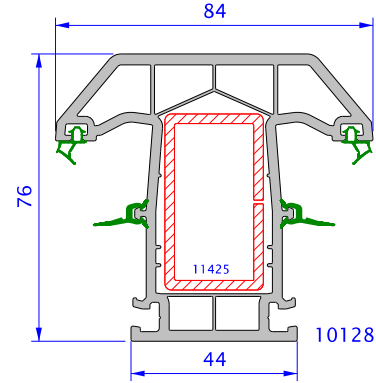
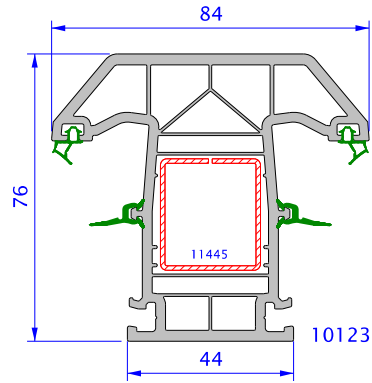
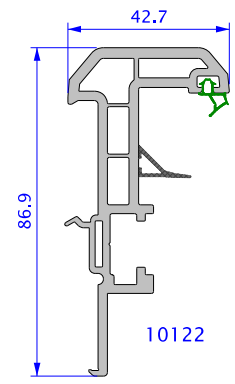
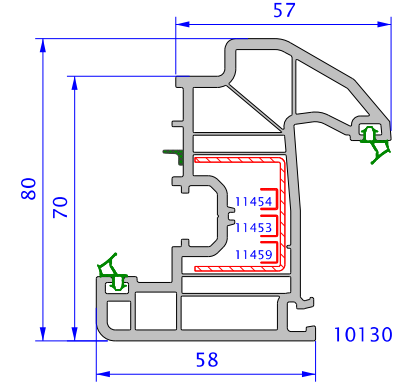
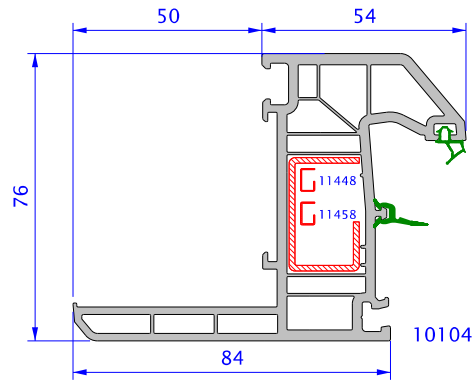
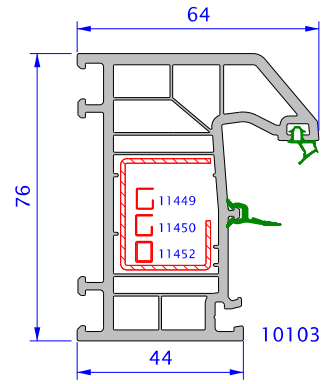

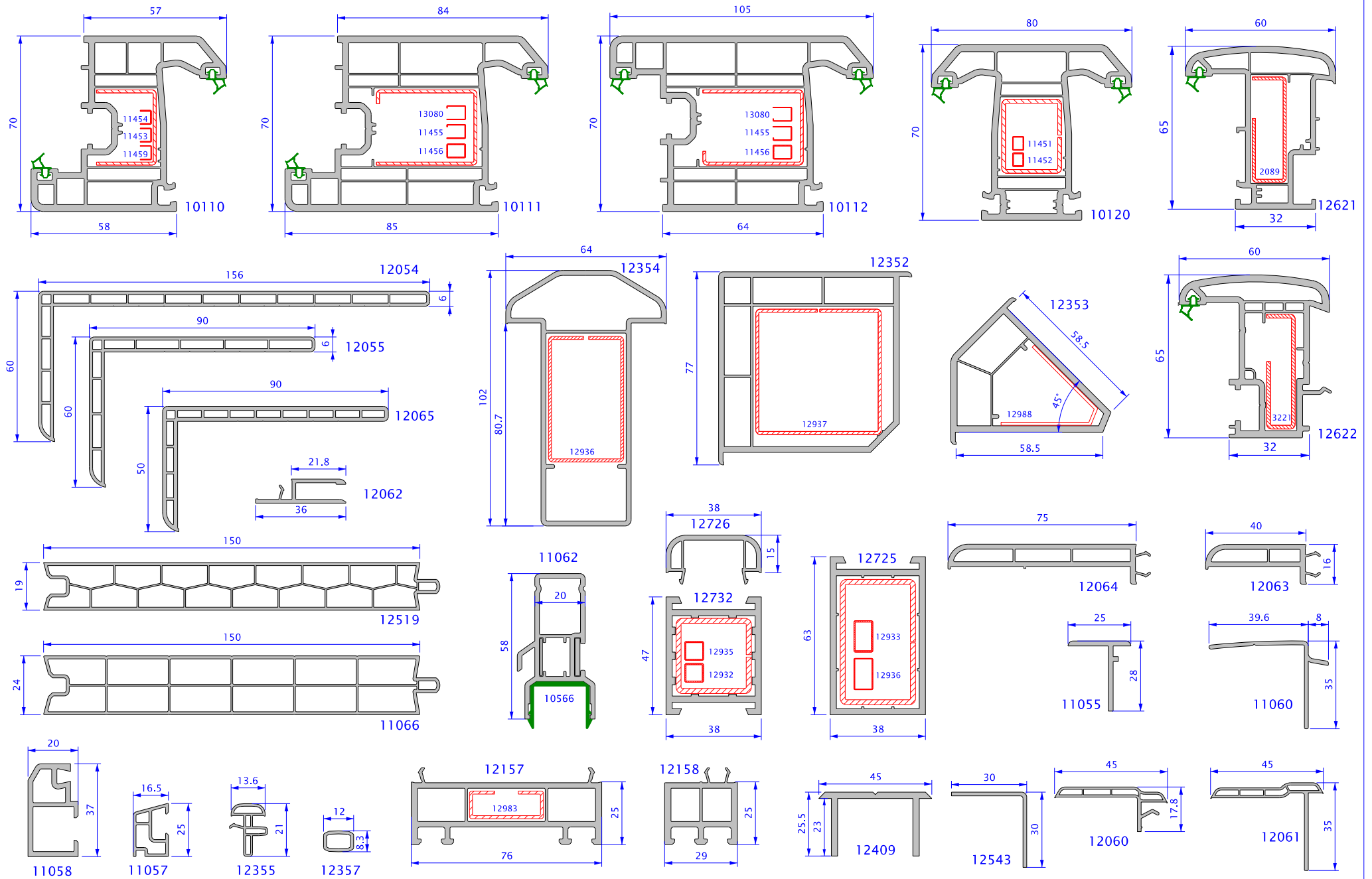

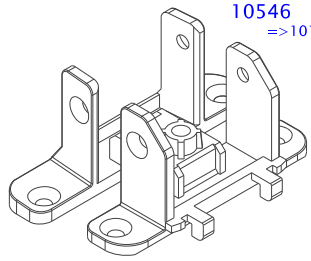

10546
=>10123/10128/10129

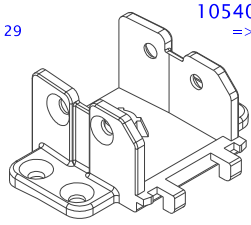

10540
=>10120

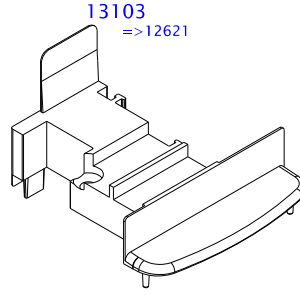

13103
=>12621

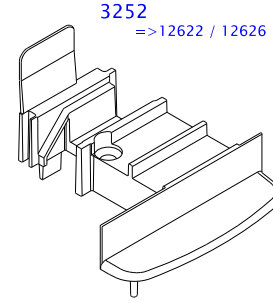

3252
=>12622 / 12626

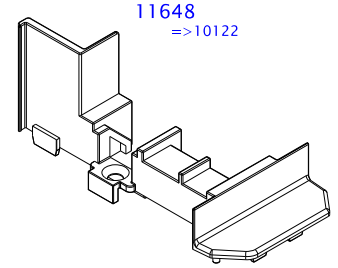

11648
=>10122

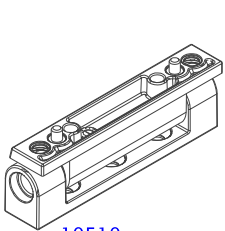

10510

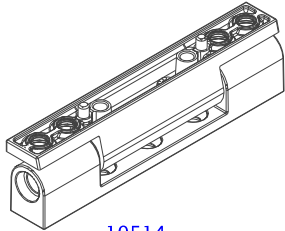

10514

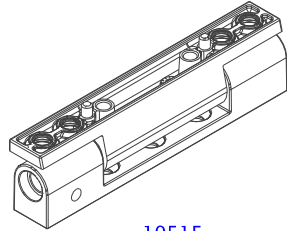

10515

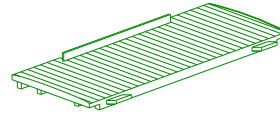

13106

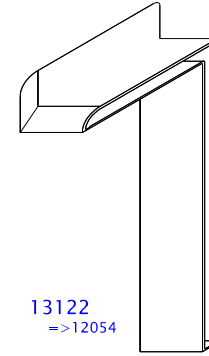

13122
=>12054

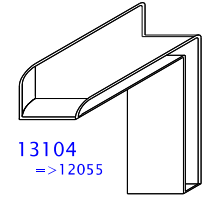

13104
=>12055

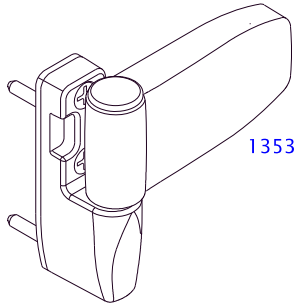

13538

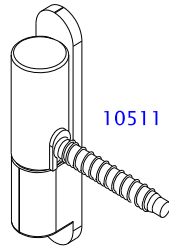

10511

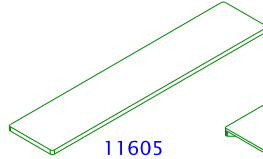

11605

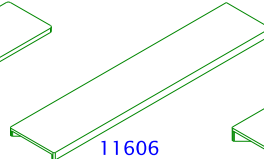

11606

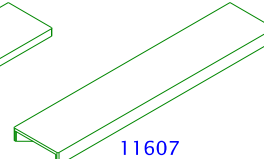

11607



11600



10579

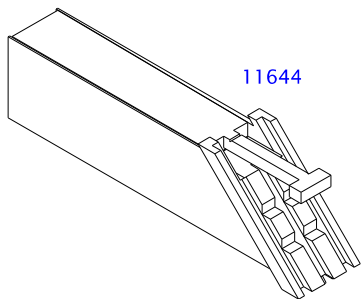

11644

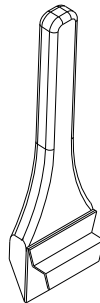

10415

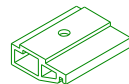

11618

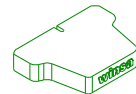

11620



11601



11619



10460
=>11057/11058



10463



10407

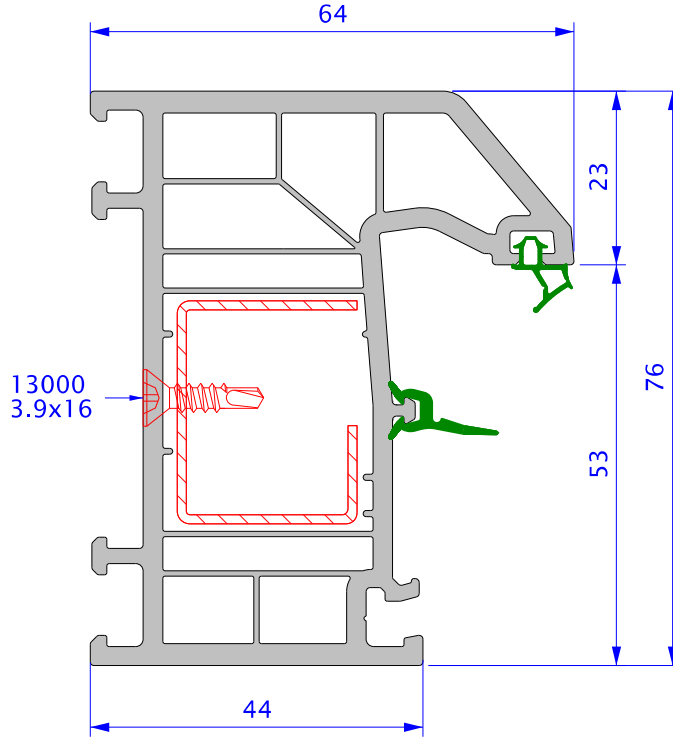

10103	
Ix (cm ⁴)	Iy (cm ⁴)
64.74	27.24

Destek Sacı		s (mm)	Ix (cm ⁴)	Iy (cm ⁴)
11449 23.8x29.5x23.8x13		1.2	1.40	0.80
11450 23.8x29.5x23.8x13		1.5	1.68	0.96
11452 23.8x29.5		2	2.25	1.57

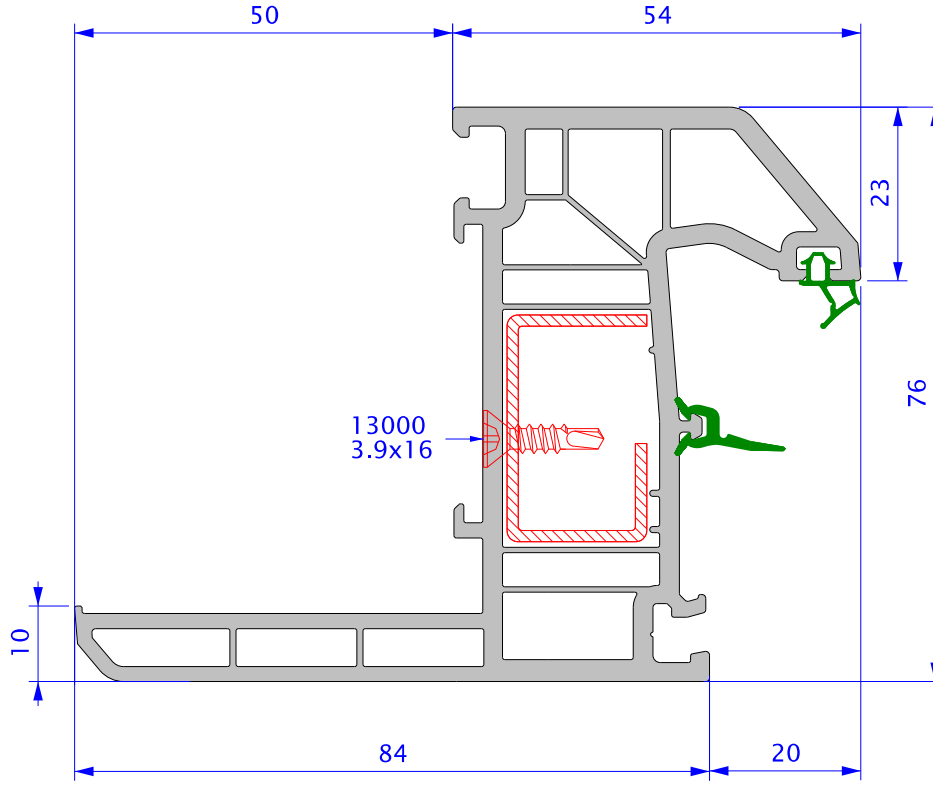

Destek Sacı		s (mm)	Ix (cm ⁴)	Iy (cm ⁴)
11448 18.5x30x18.5x13		1.2	1.17	0.43
11458 18.5x30x18.5x13		1.5	1.45	0.53

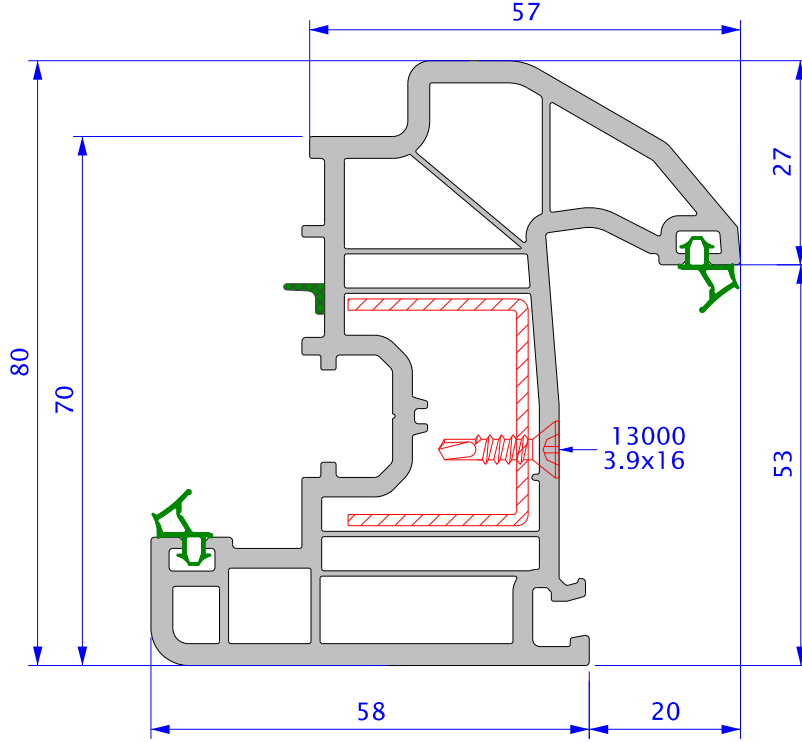

10130	
Ix (cm ⁴)	Iy (cm ⁴)
71.47	37.18

Destek Sacı		s (mm)	Ix (cm ⁴)	Iy (cm ⁴)
11459 23.8x30x23.8		1.2	1.37	0.53
11453 23.8x30x23.8		1.5	1.66	0.64
11454 23.8x30x23.8		2	2.10	0.83

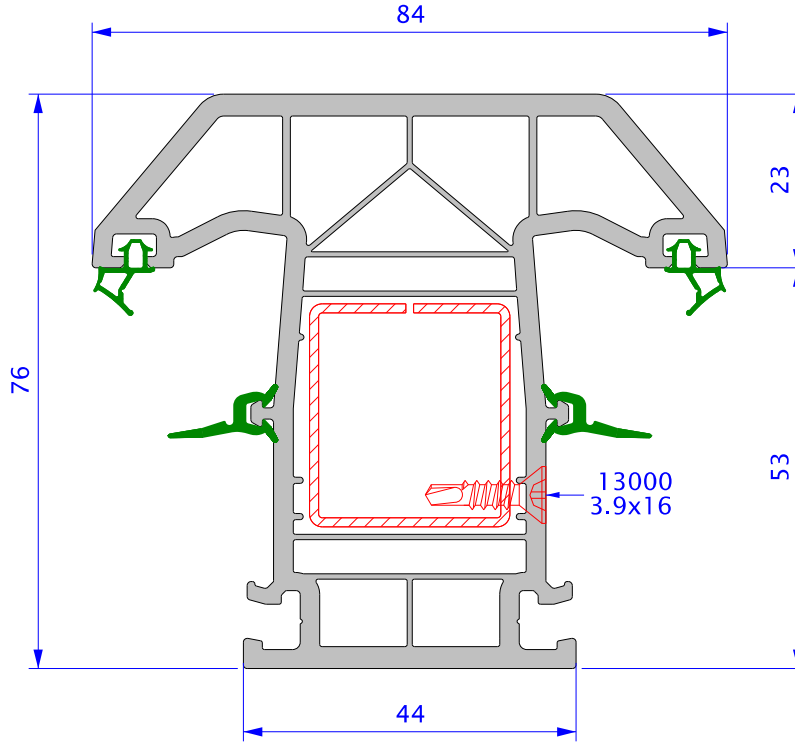

10123	
Ix (cm ⁴)	Iy (cm ⁴)
70.03	44.48

Destek Sacı		s (mm)	Ix (cm ⁴)	Iy (cm ⁴)
11445 26.5x29.5		1.2	1.60	1.37

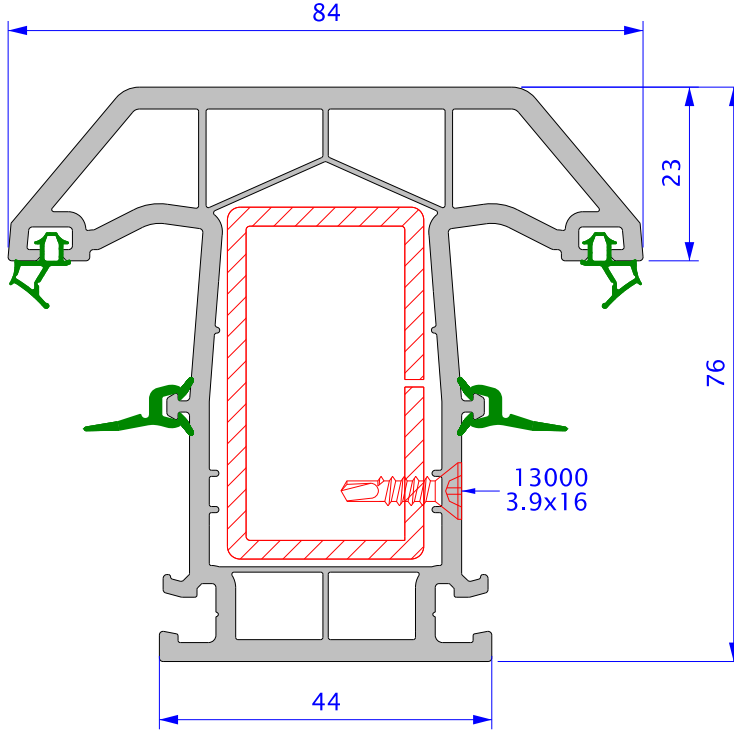

10128	
Ix (cm ⁴)	Iy (cm ⁴)
68.28	43.55

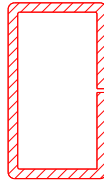
Destek Sacı		s (mm)	Ix (cm ⁴)	Iy (cm ⁴)
11425 26x46.5		2.5	9.15	3.53

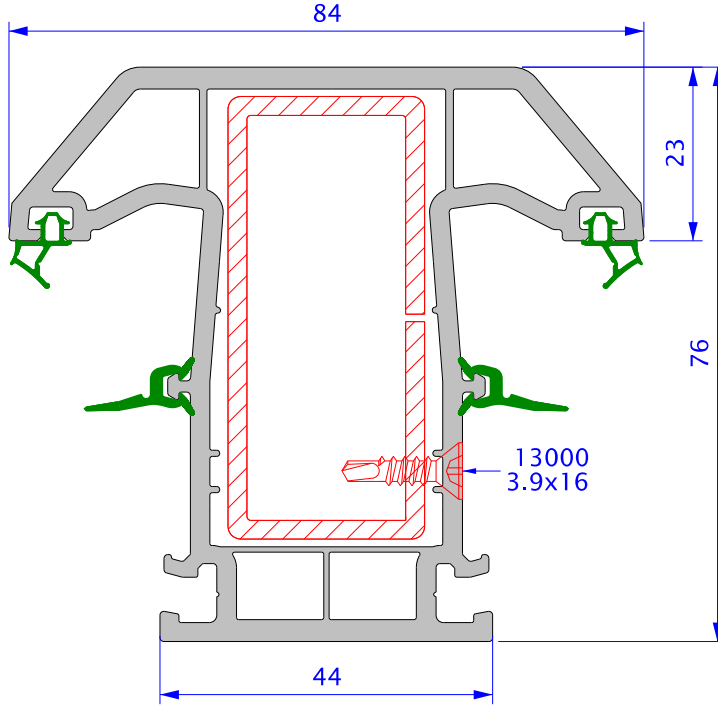

10129	
Ix (cm ⁴)	Iy (cm ⁴)
67.08	43.89

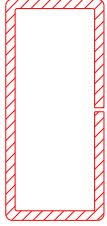
Destek Sacı		s (mm)	Ix (cm ⁴)	Iy (cm ⁴)
11426 26x58.5		2.5	16.38	4.36

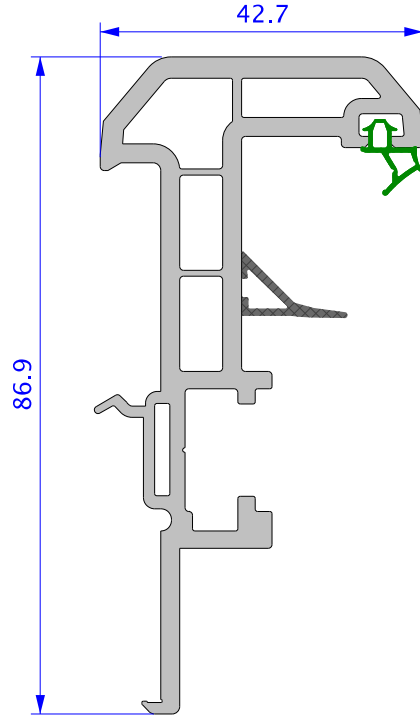

10122	
Ix (cm ⁴)	Iy (cm ⁴)
38.30	6.03

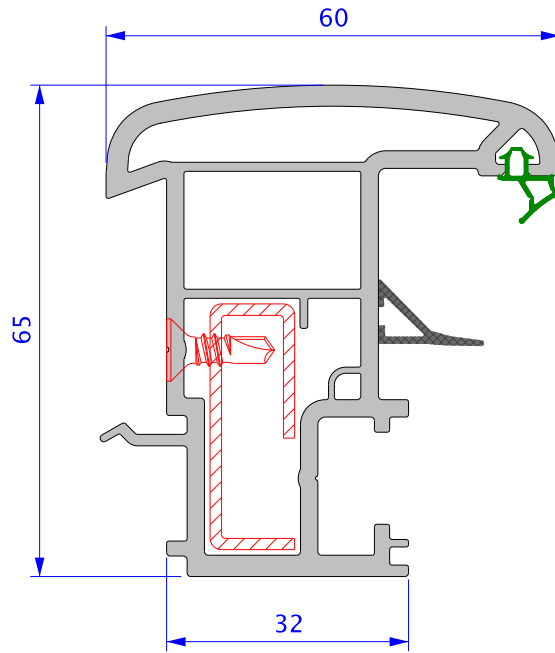

12626	
Ix (cm ⁴)	Iy (cm ⁴)
34.8	16.29

Kanat Adaptör Kapak

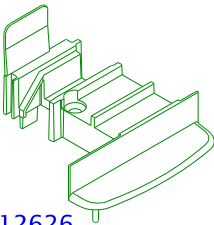

3252
=>12626

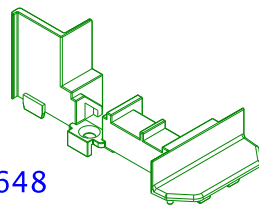

11648
=>10122

Destek Sacı



11442
11.2x32.5x11.2x17.7

s
(mm)

Ix
(cm⁴)

Iy
(cm⁴)

1.5

1.23

0.18

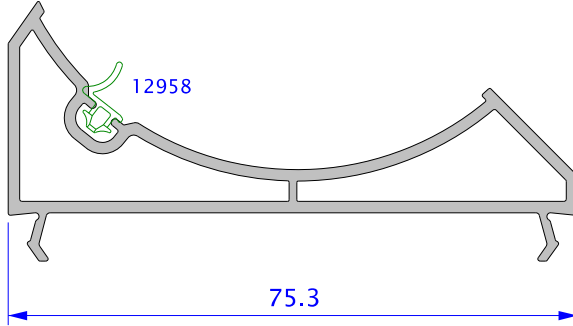

11034	
Ix (cm ⁴)	Iy (cm ⁴)
38.30	6.03

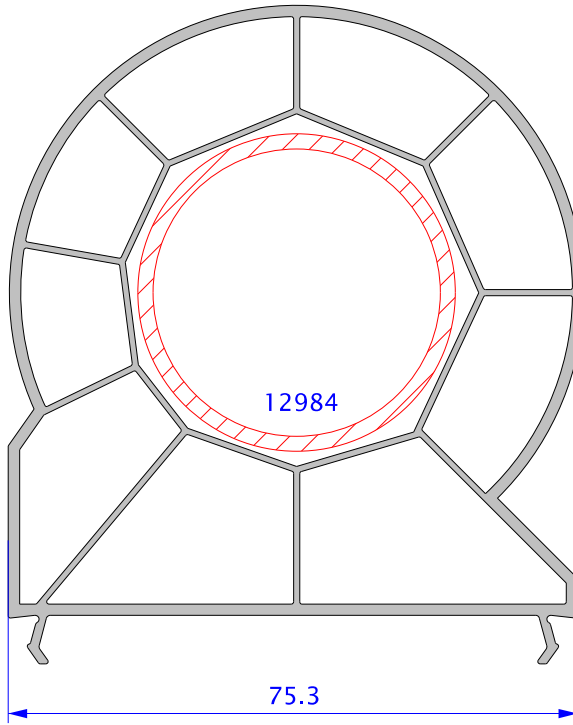

11035	
Ix (cm ⁴)	Iy (cm ⁴)
38.30	6.03

Destek Sacı		s (mm)	Ix (cm ⁴)	Iy (cm ⁴)
12984 Ø 40		2	5.03	5.03

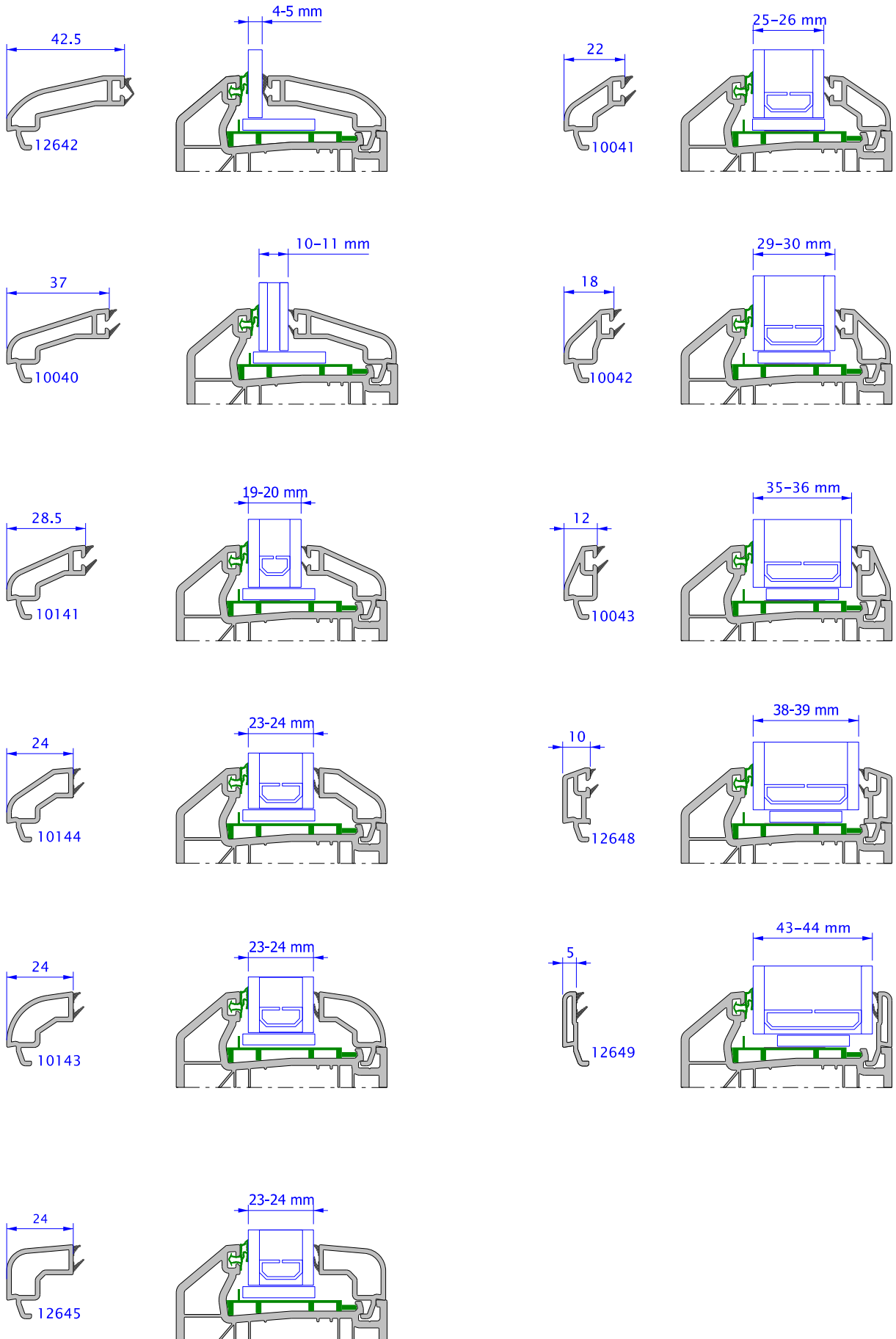

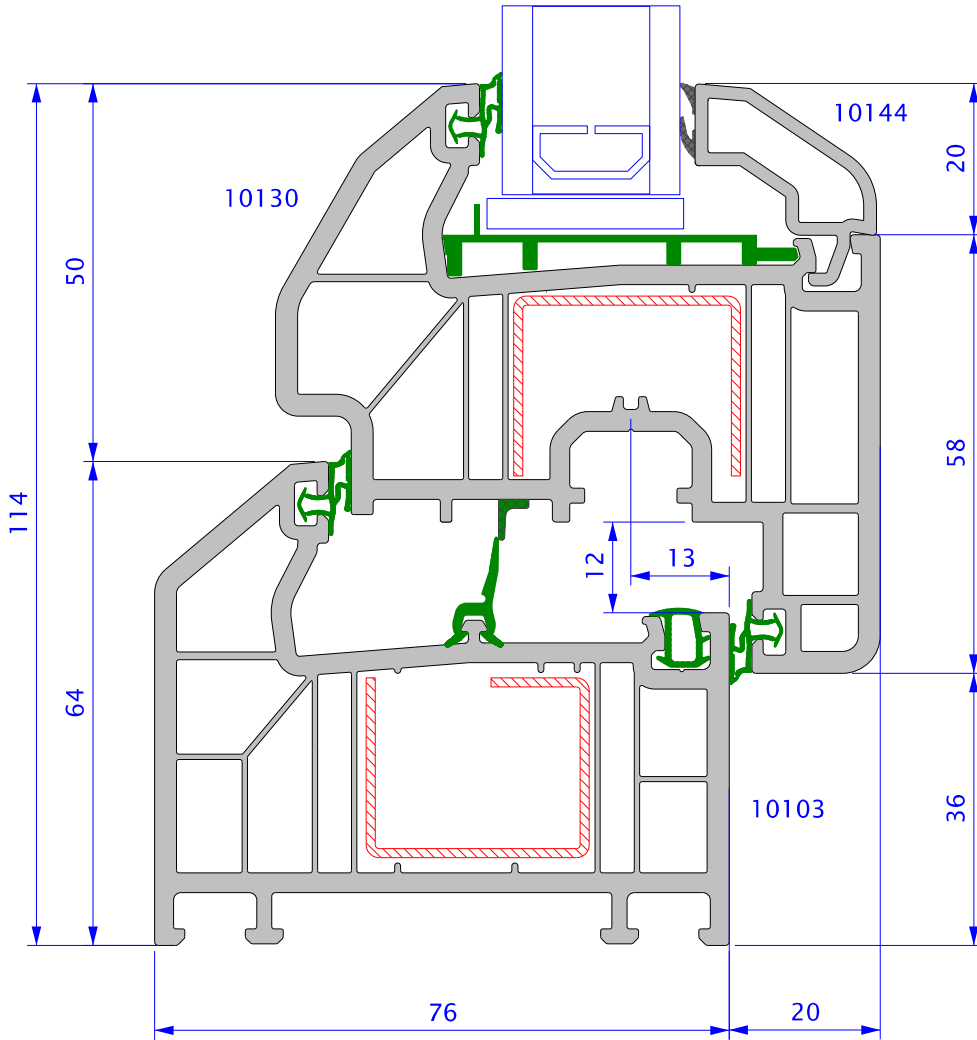
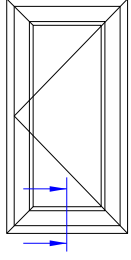

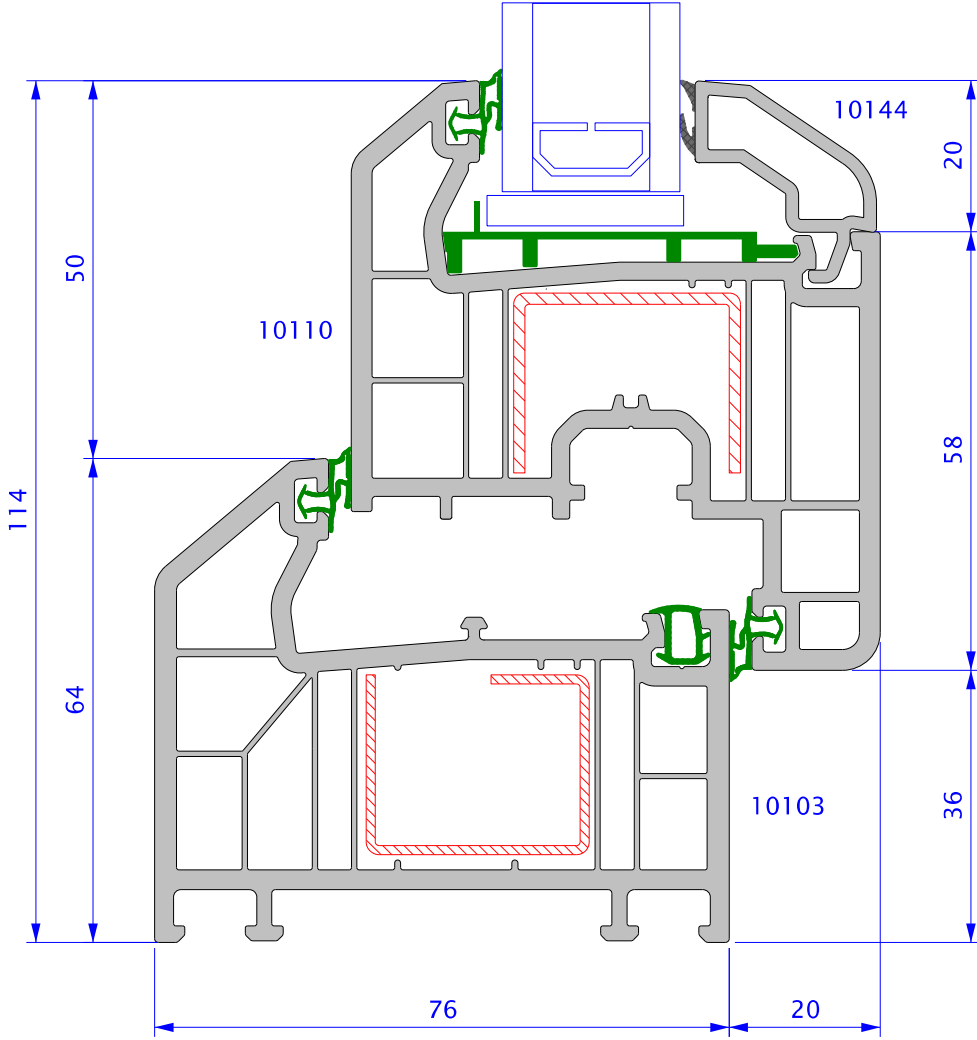
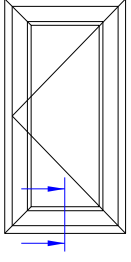

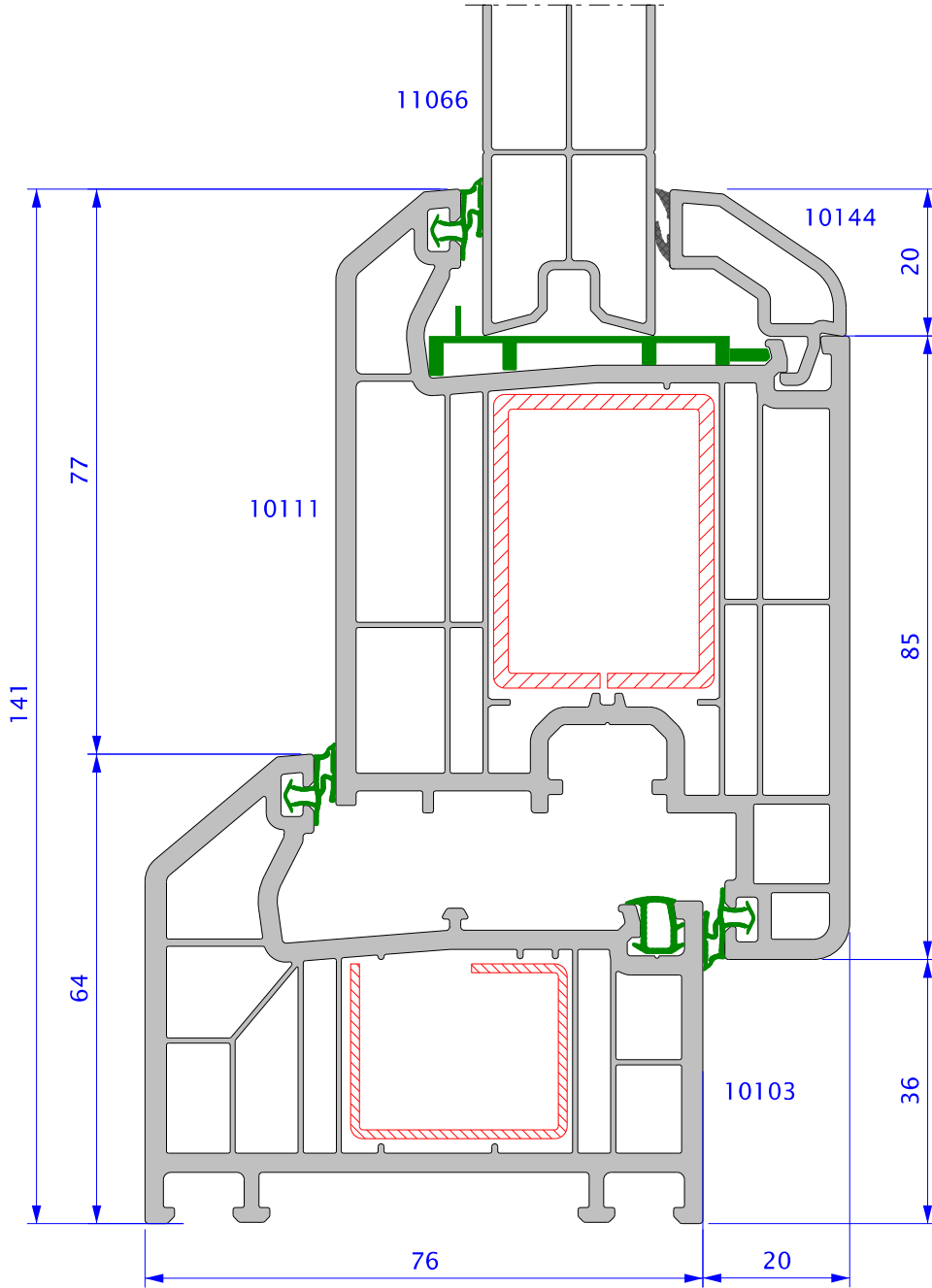
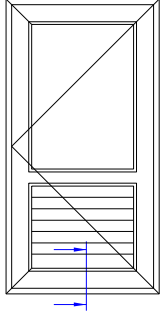

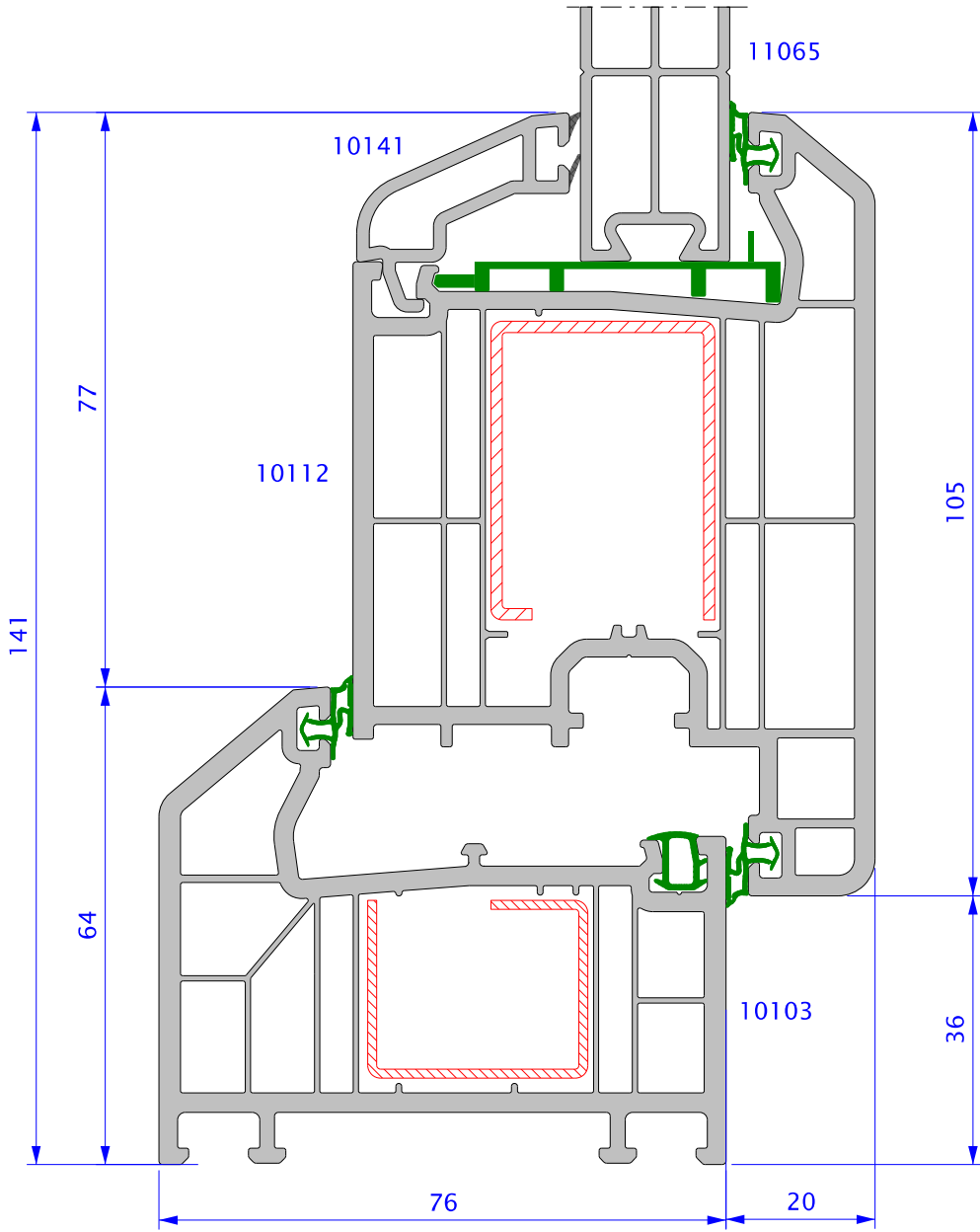
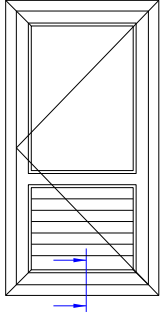

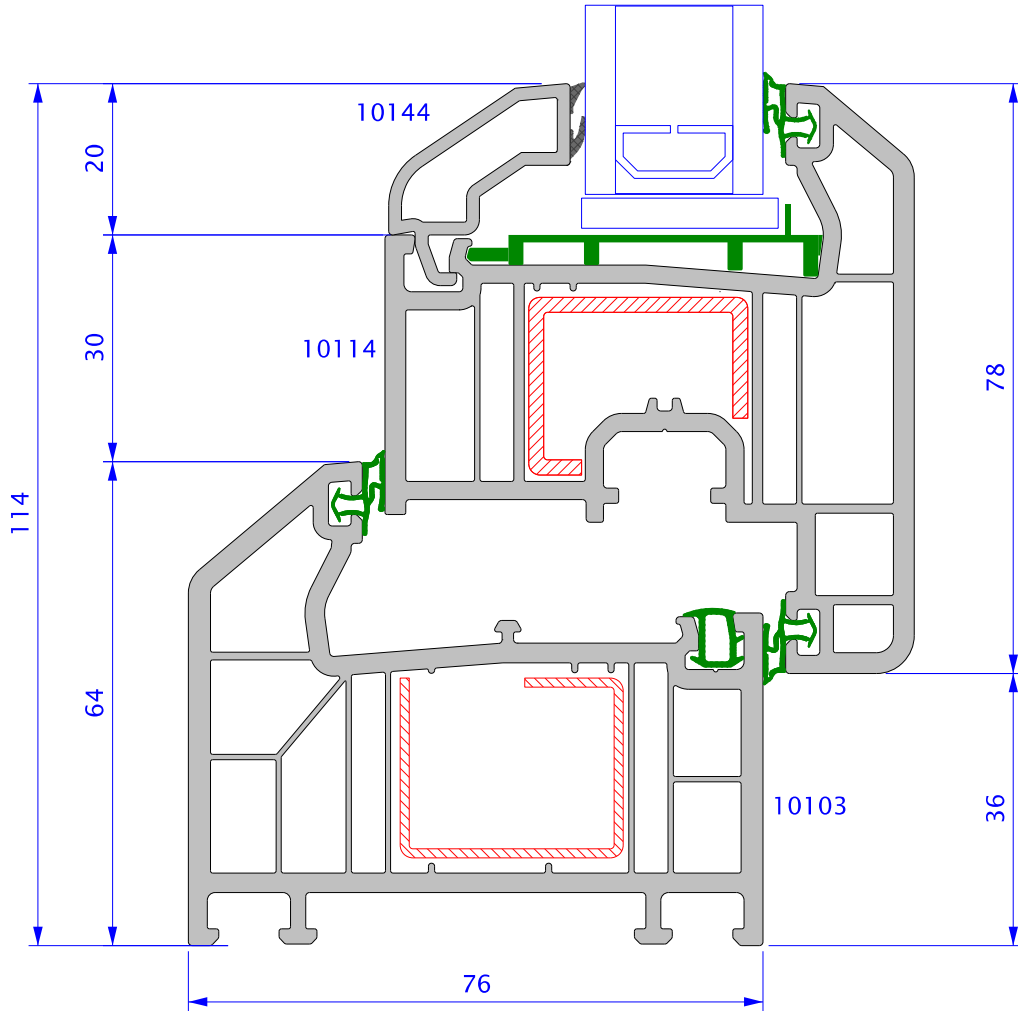
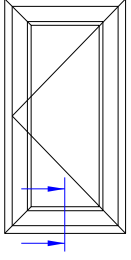

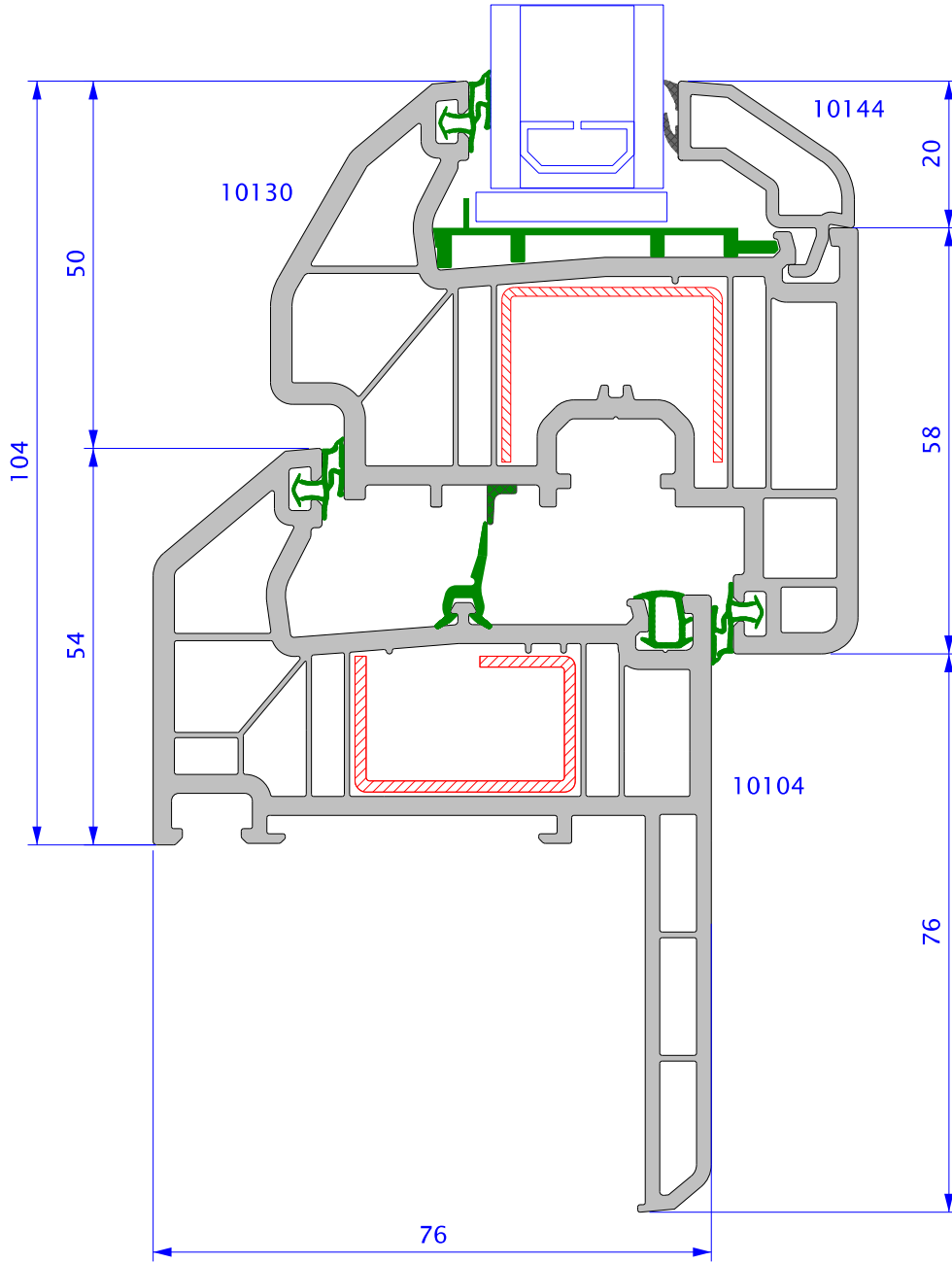
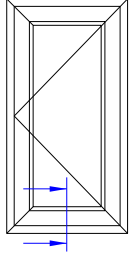

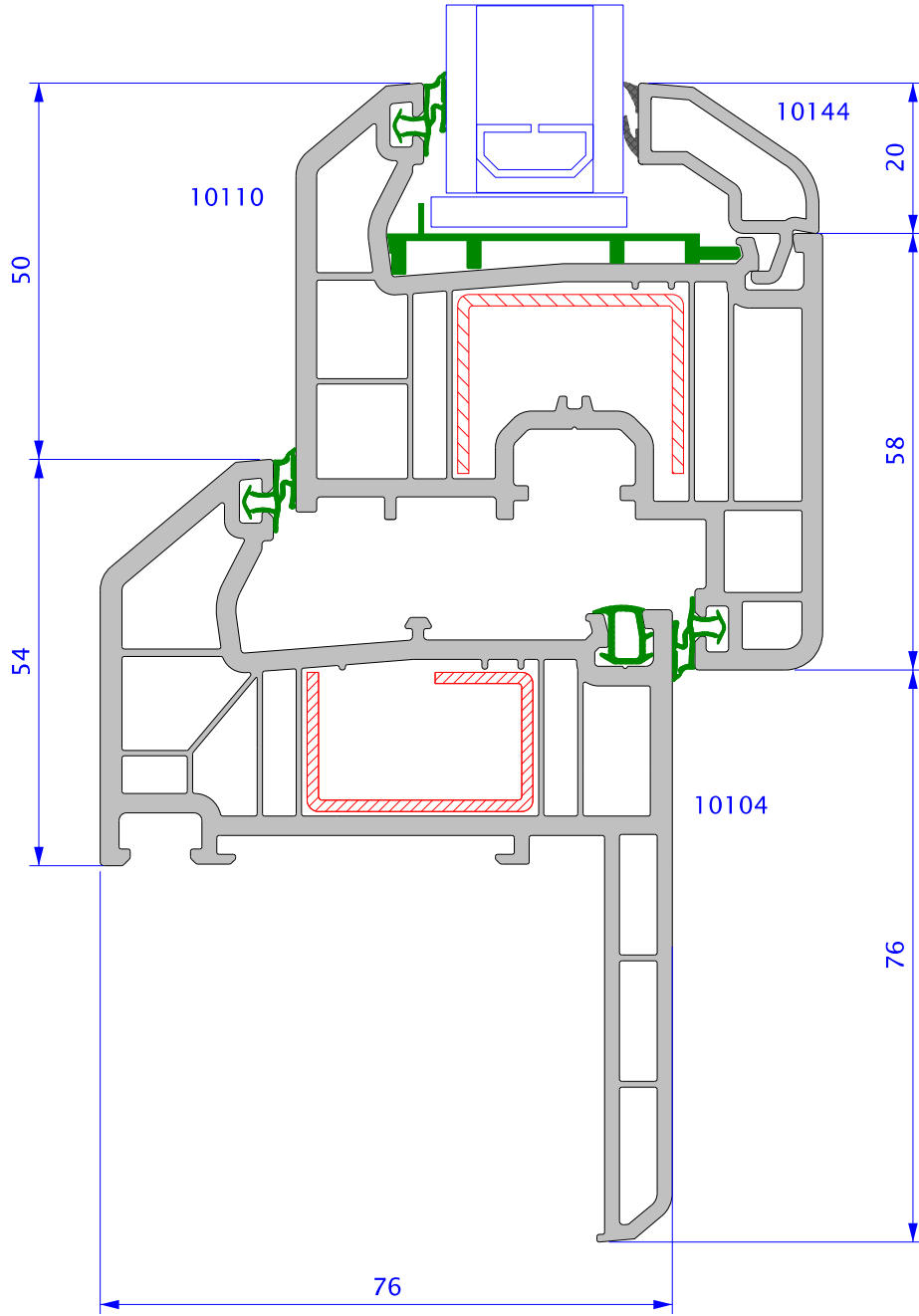
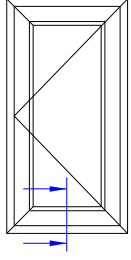

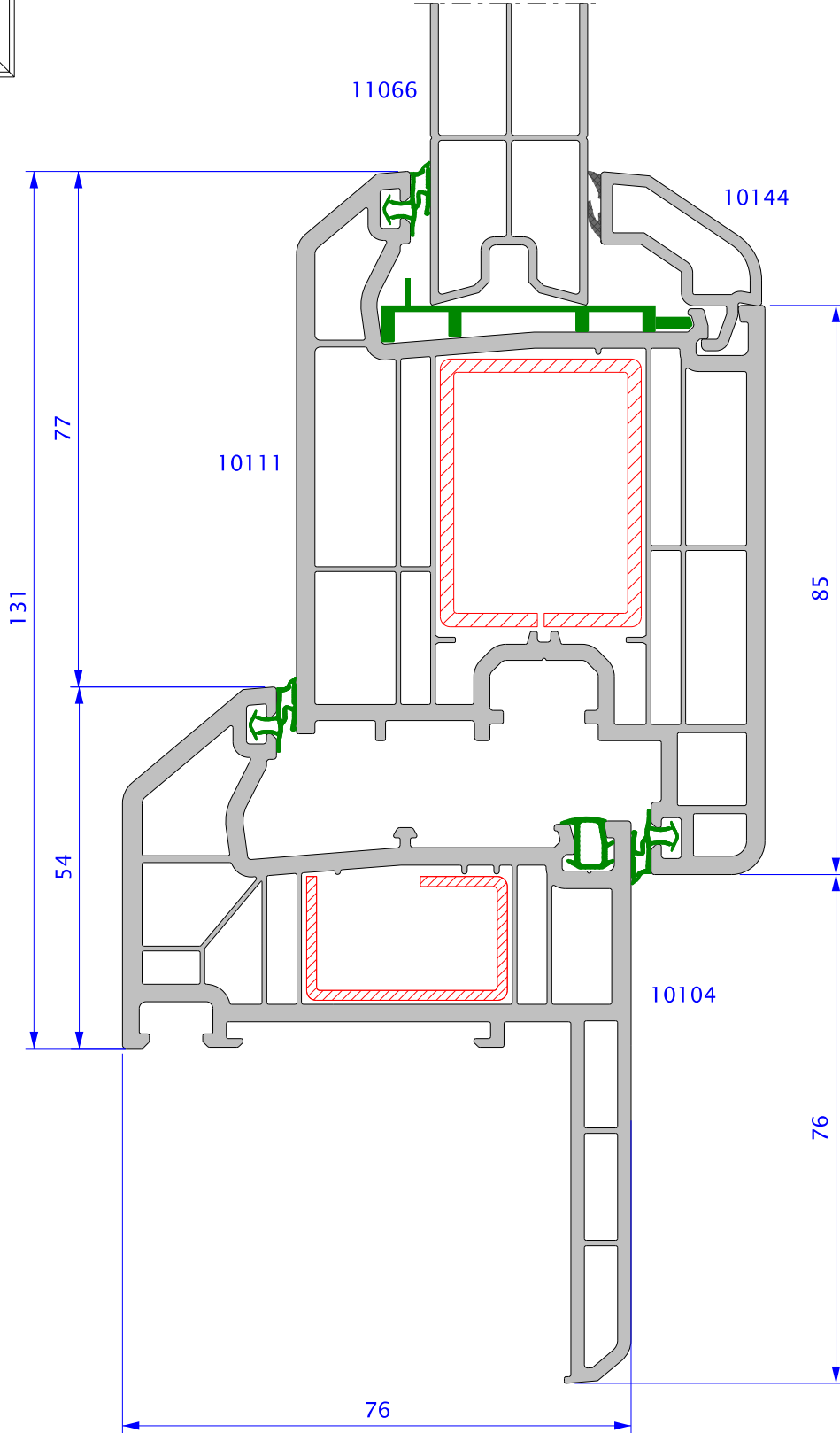
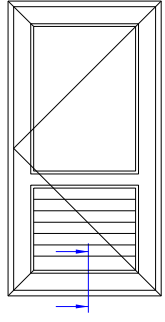

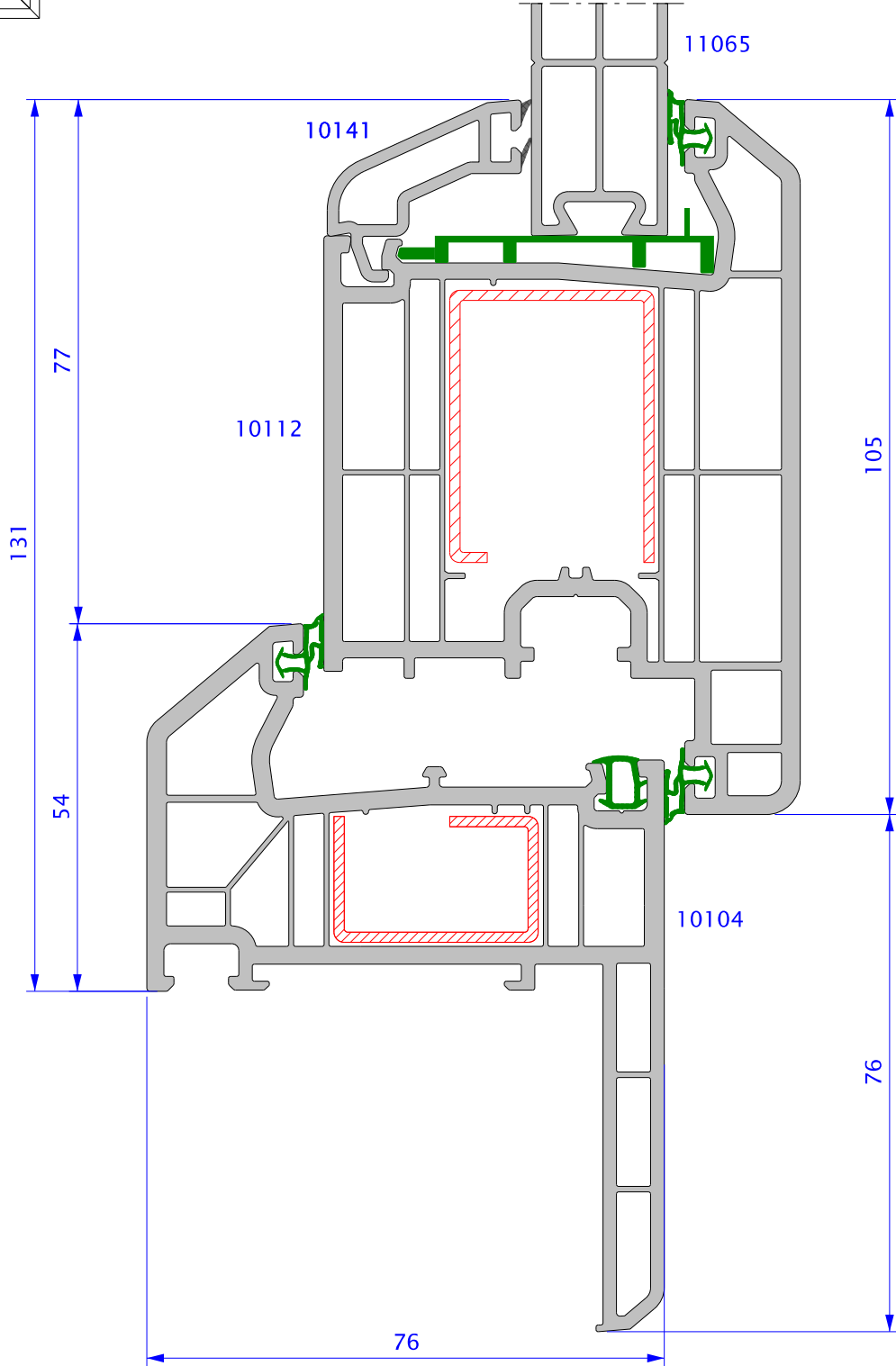
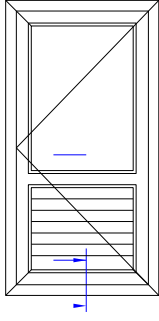

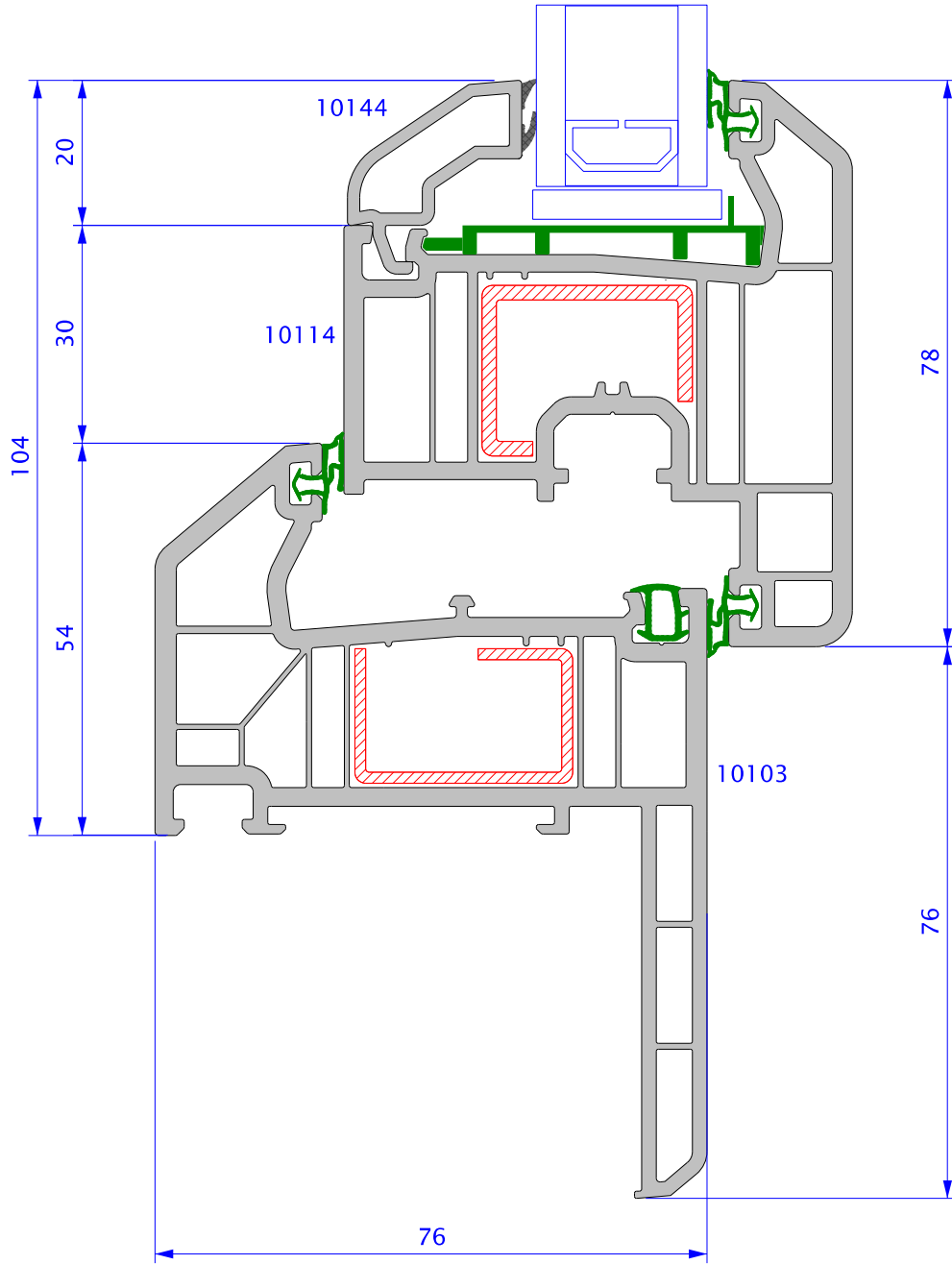
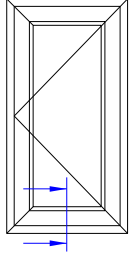

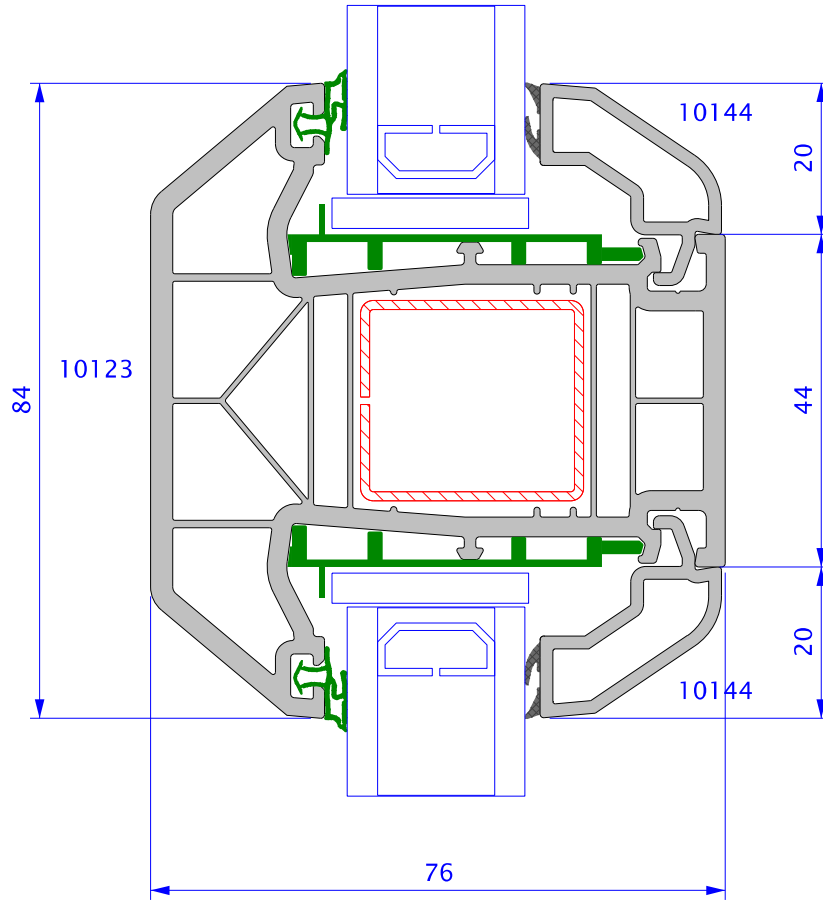
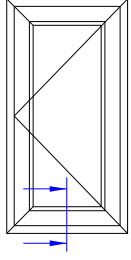

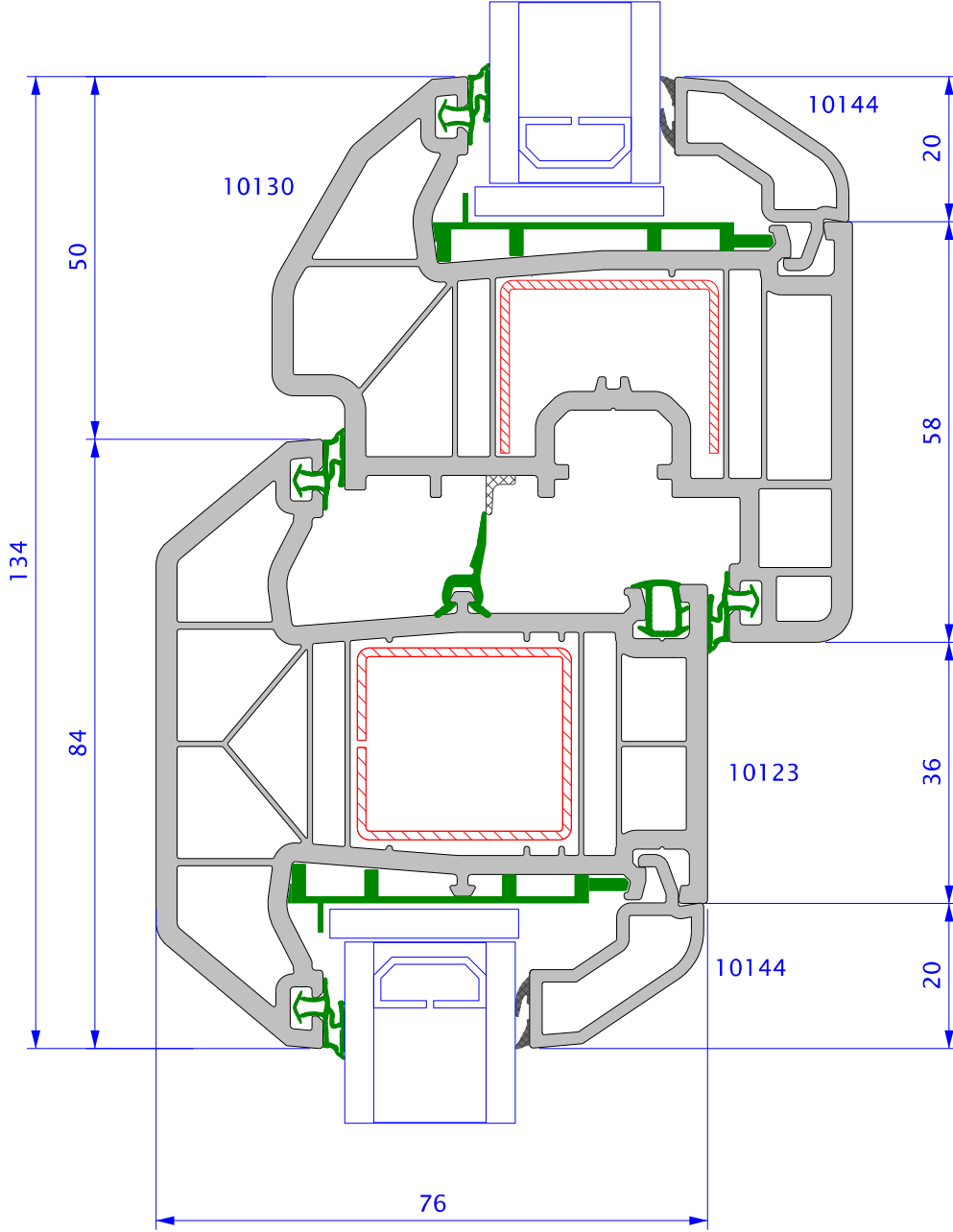
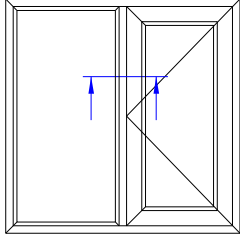

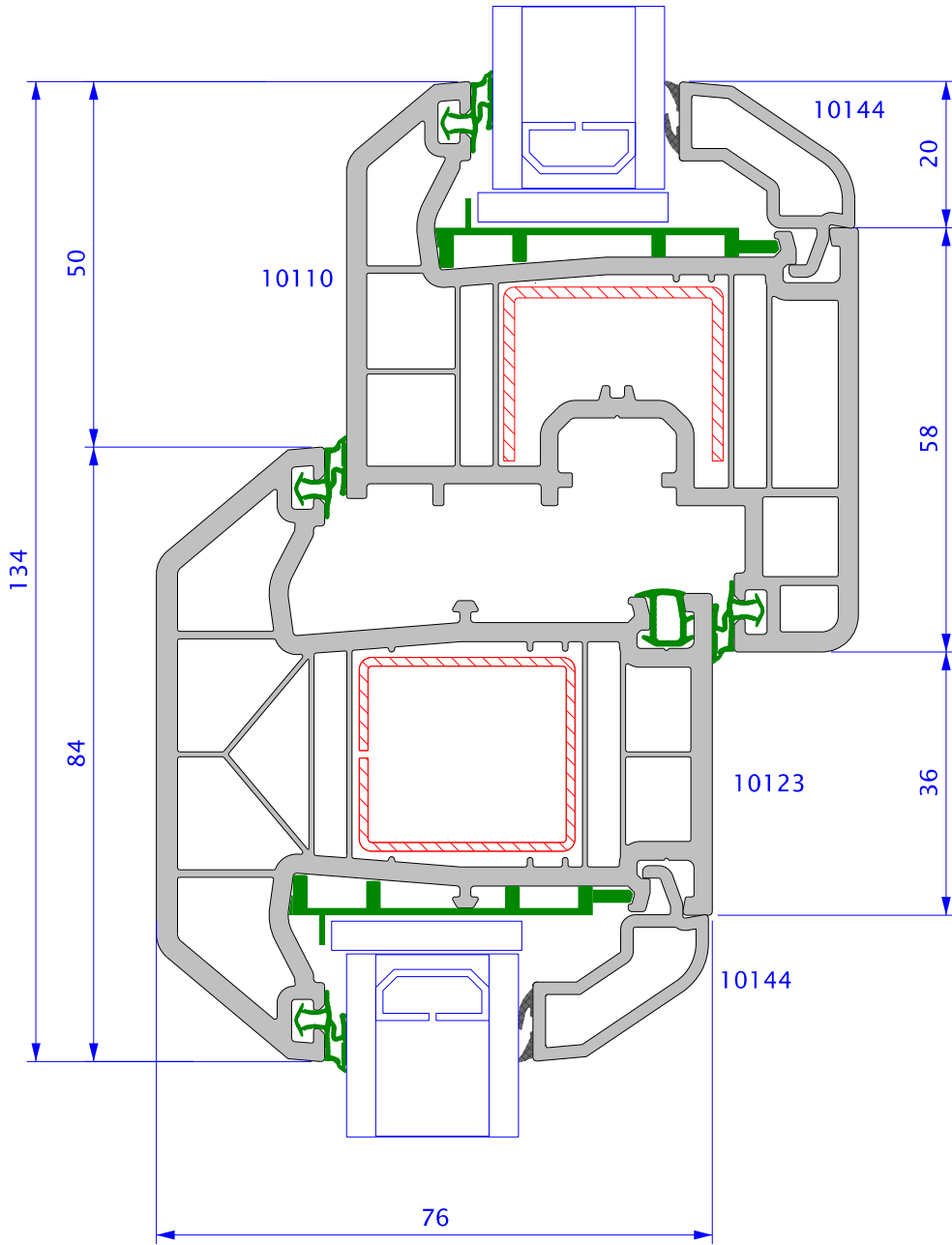
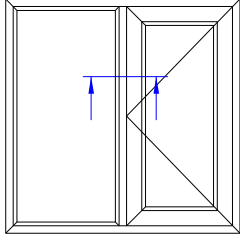

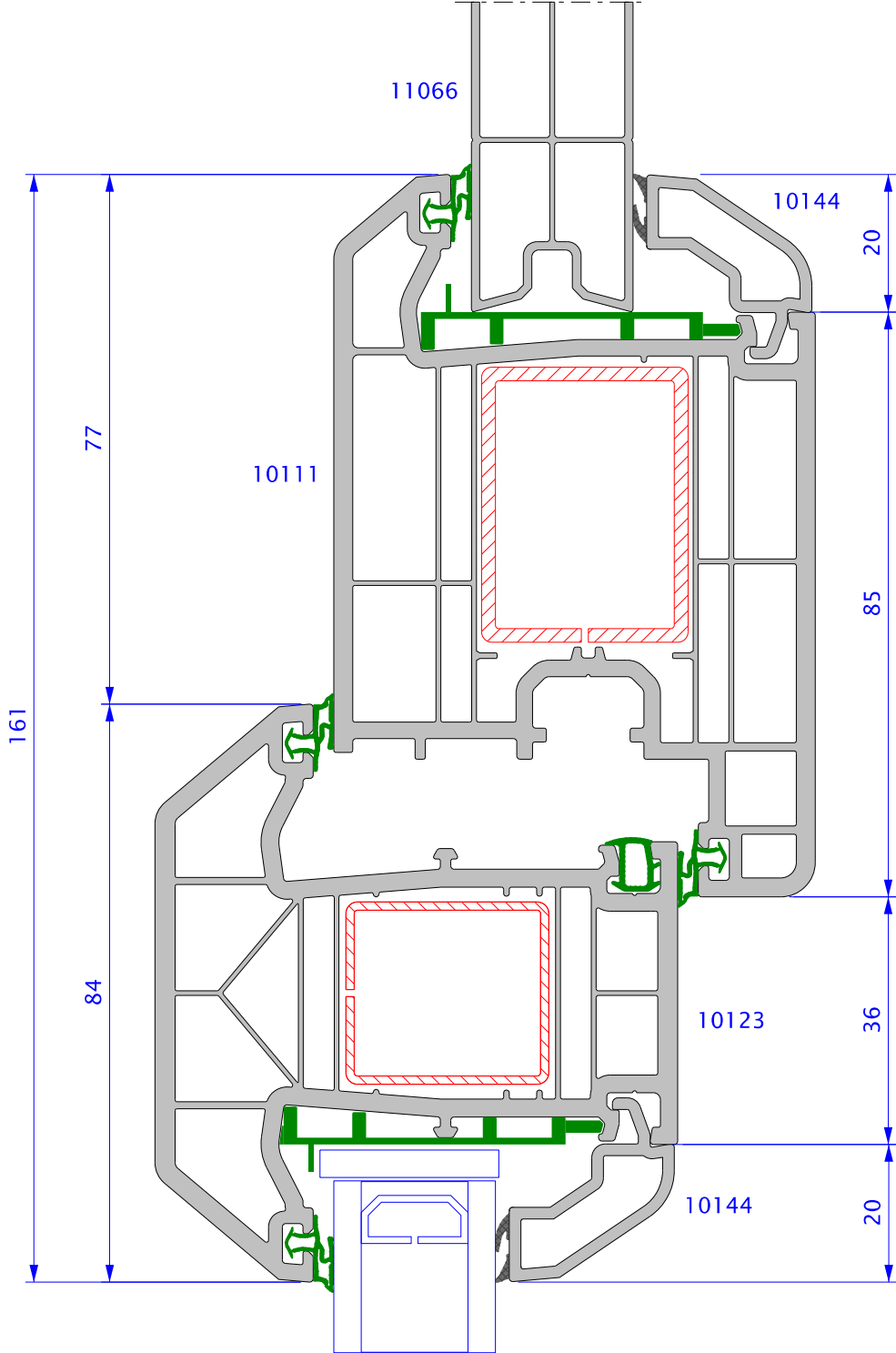
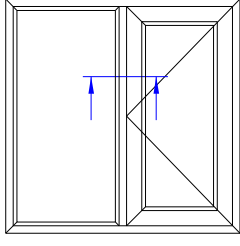

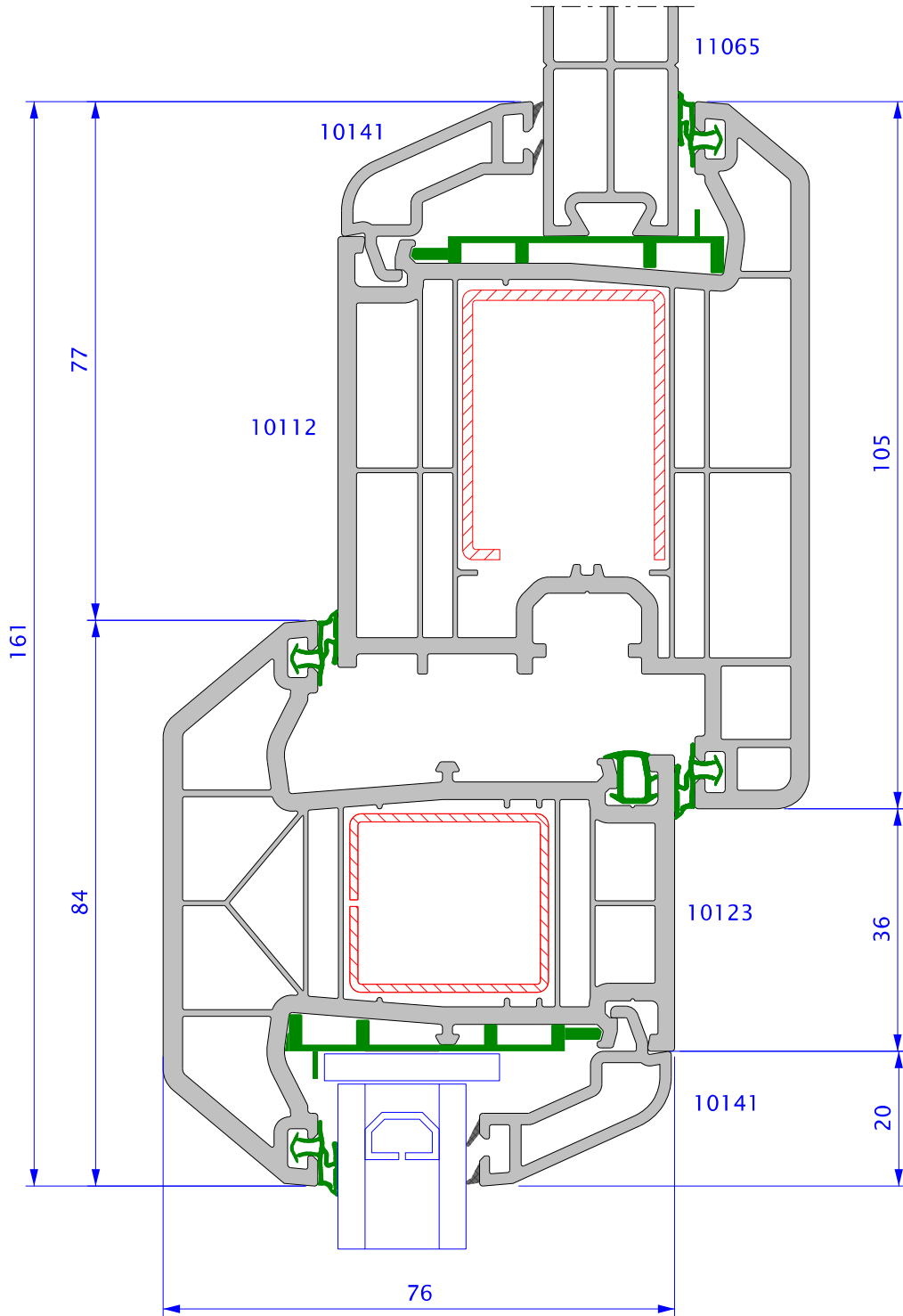
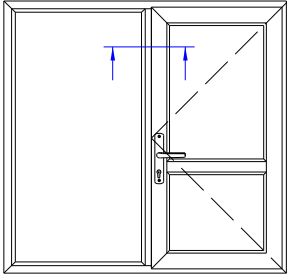

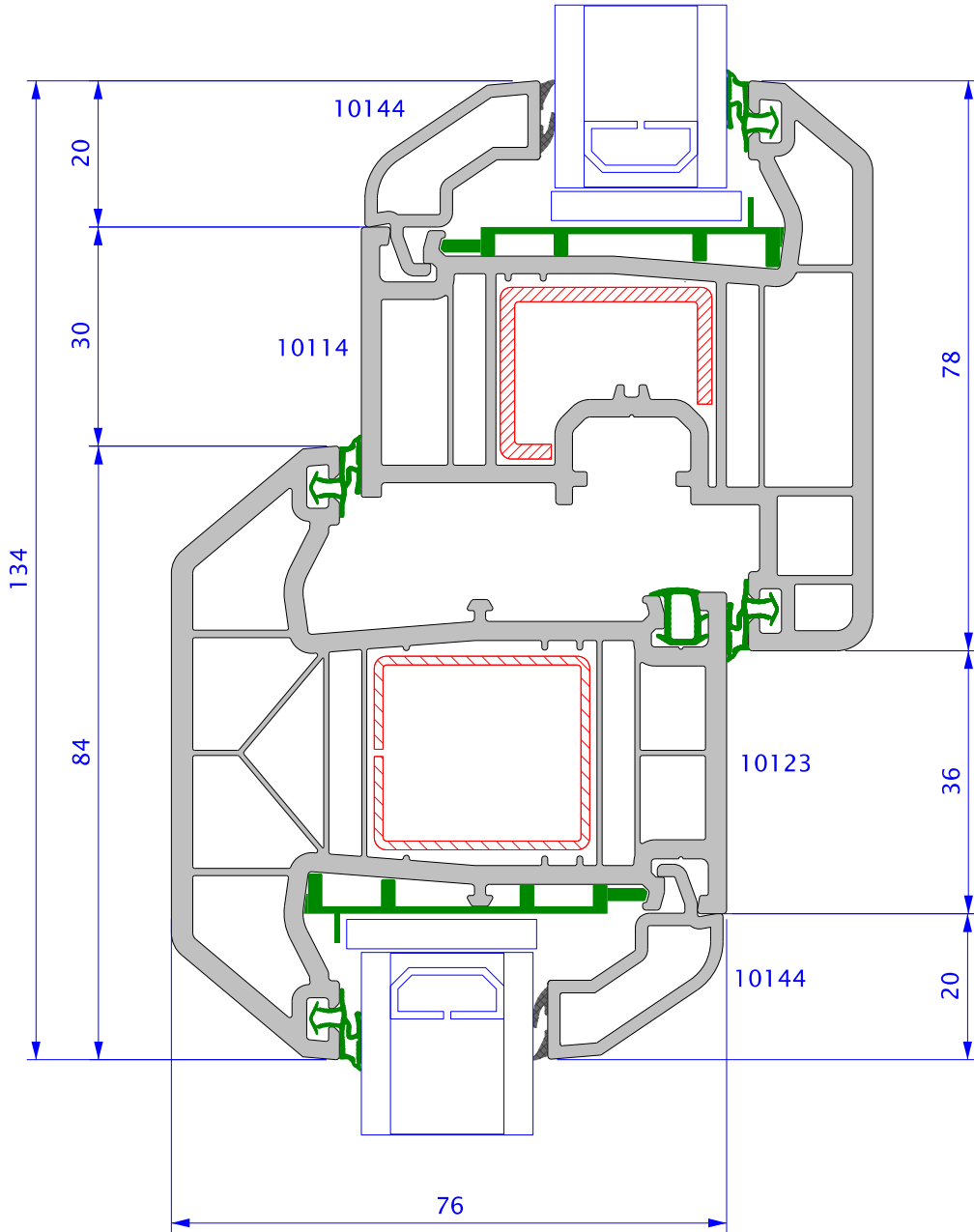
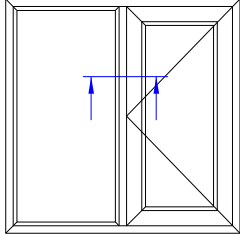

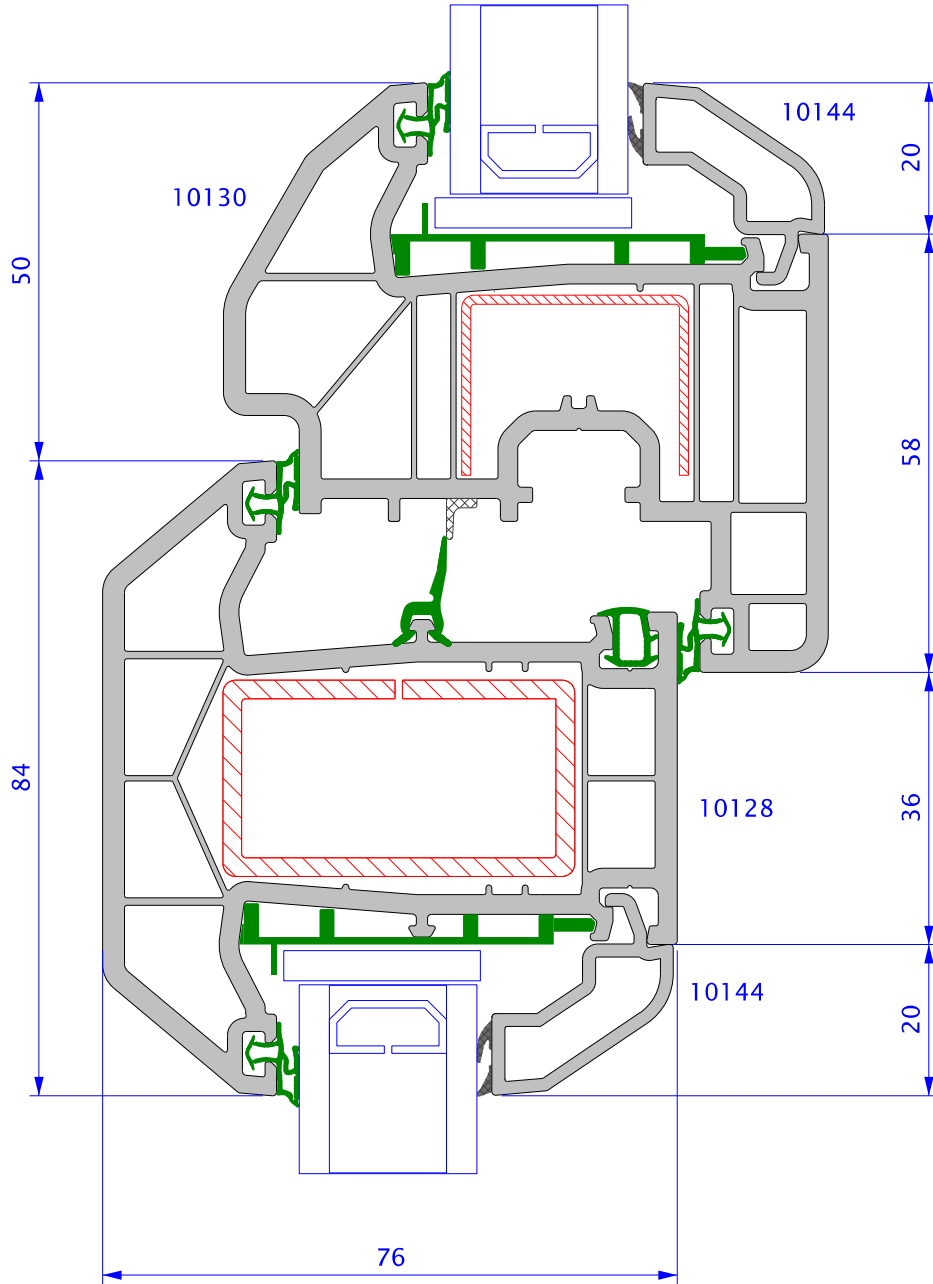
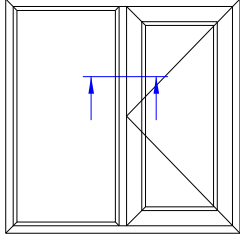

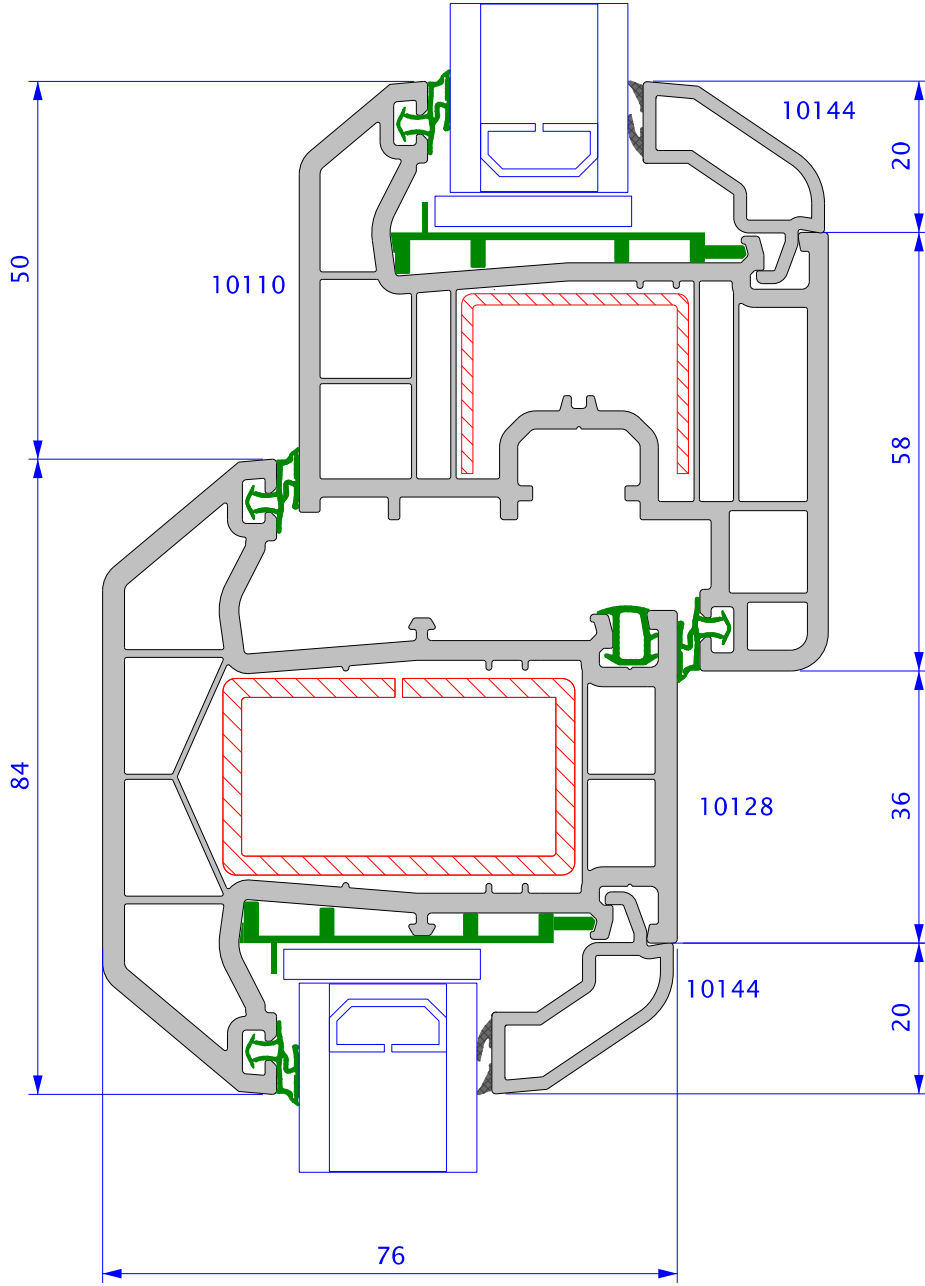
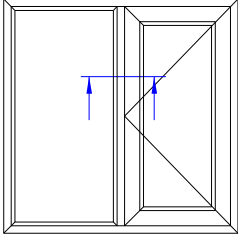

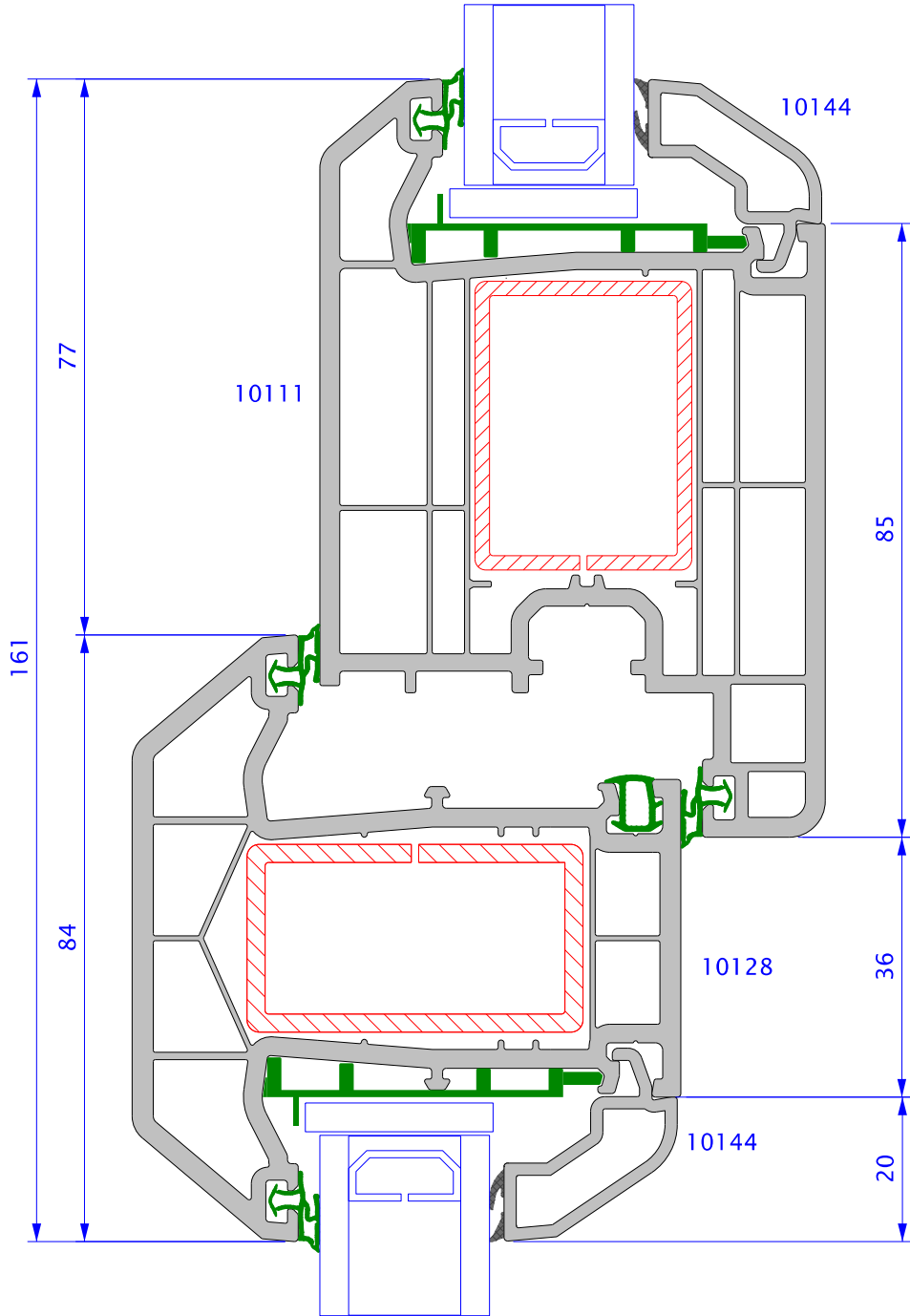
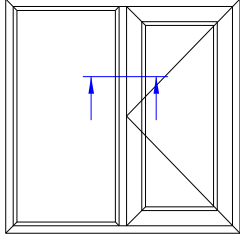

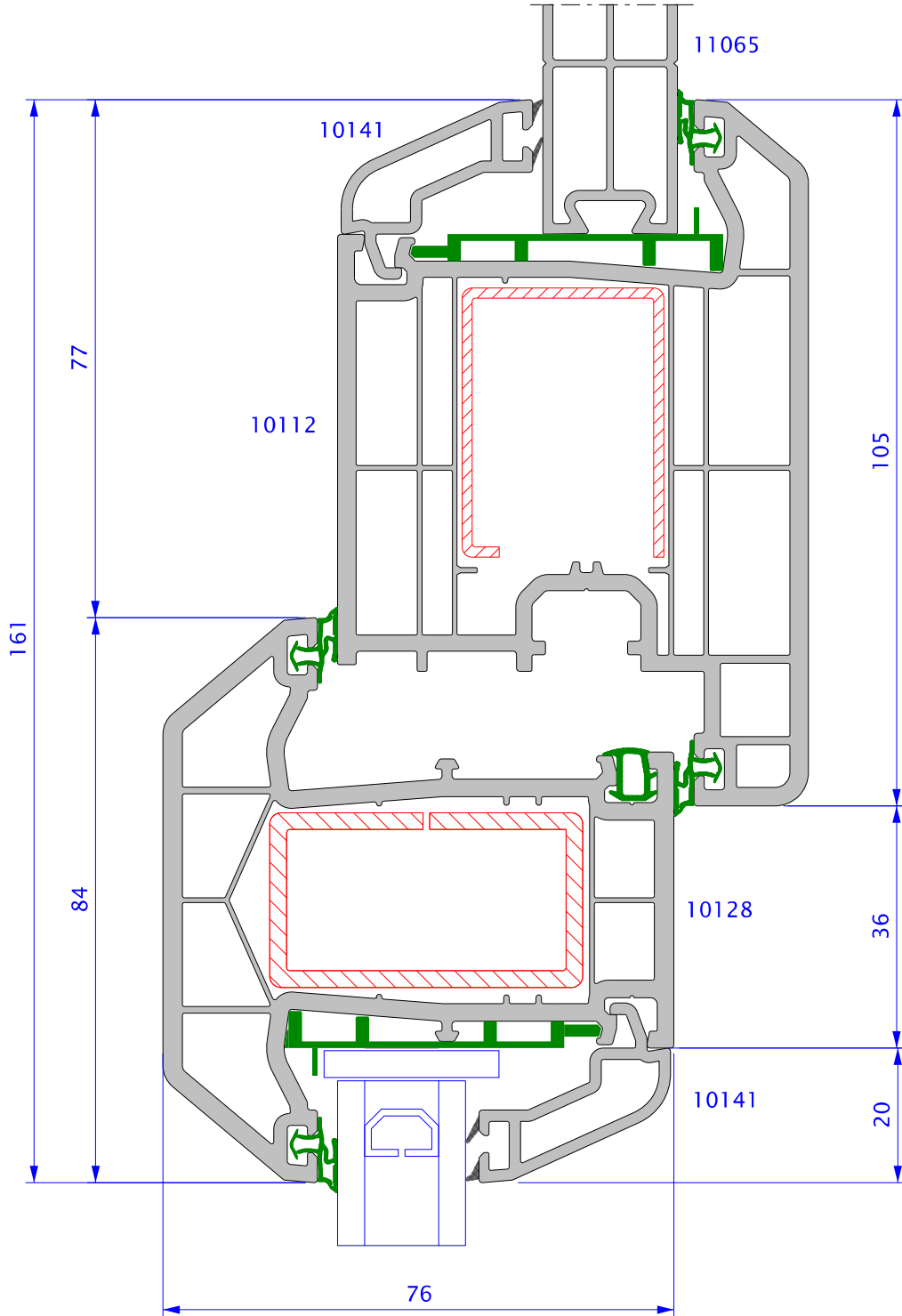
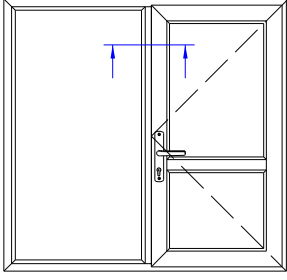

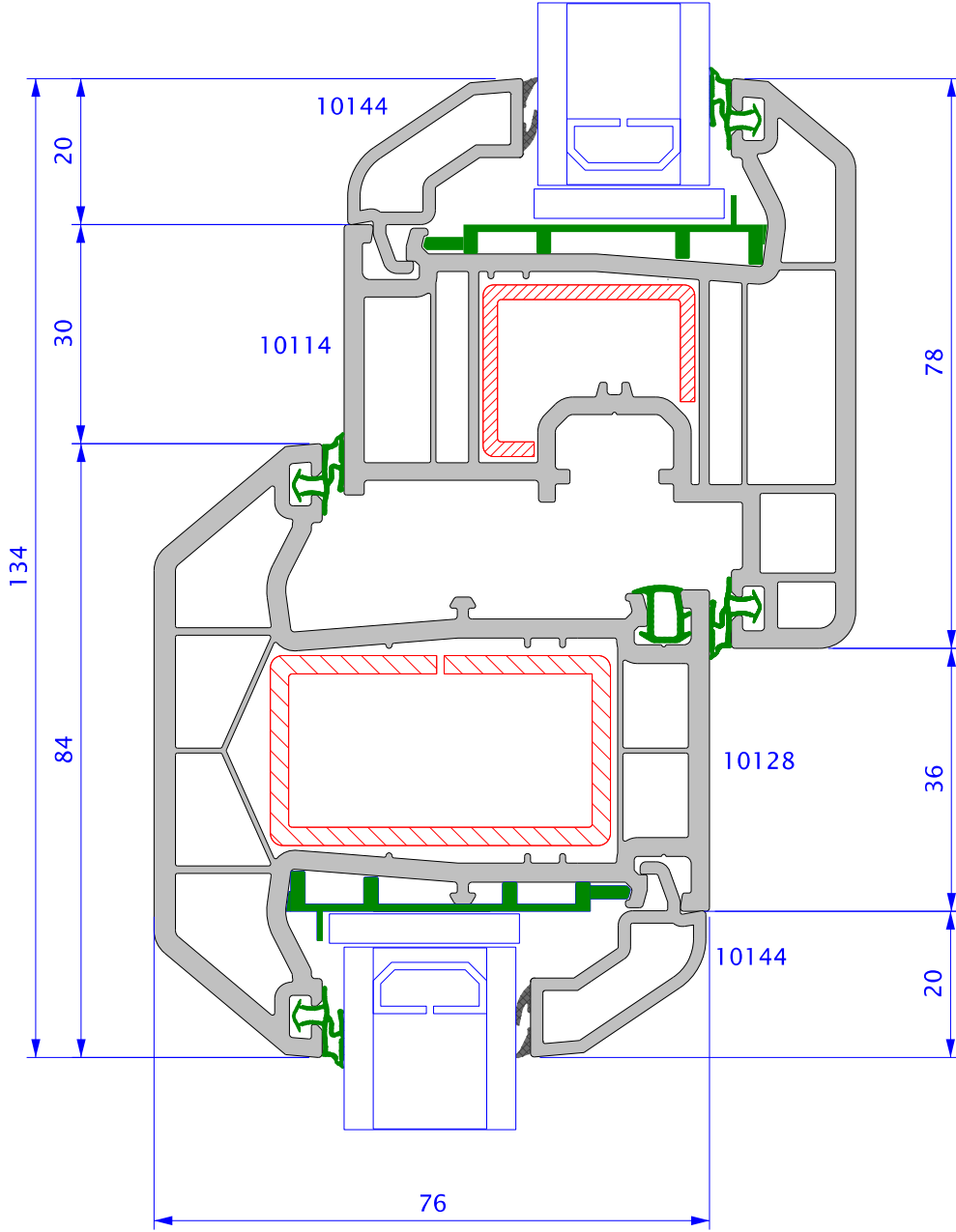
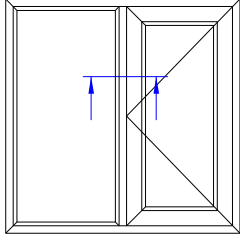

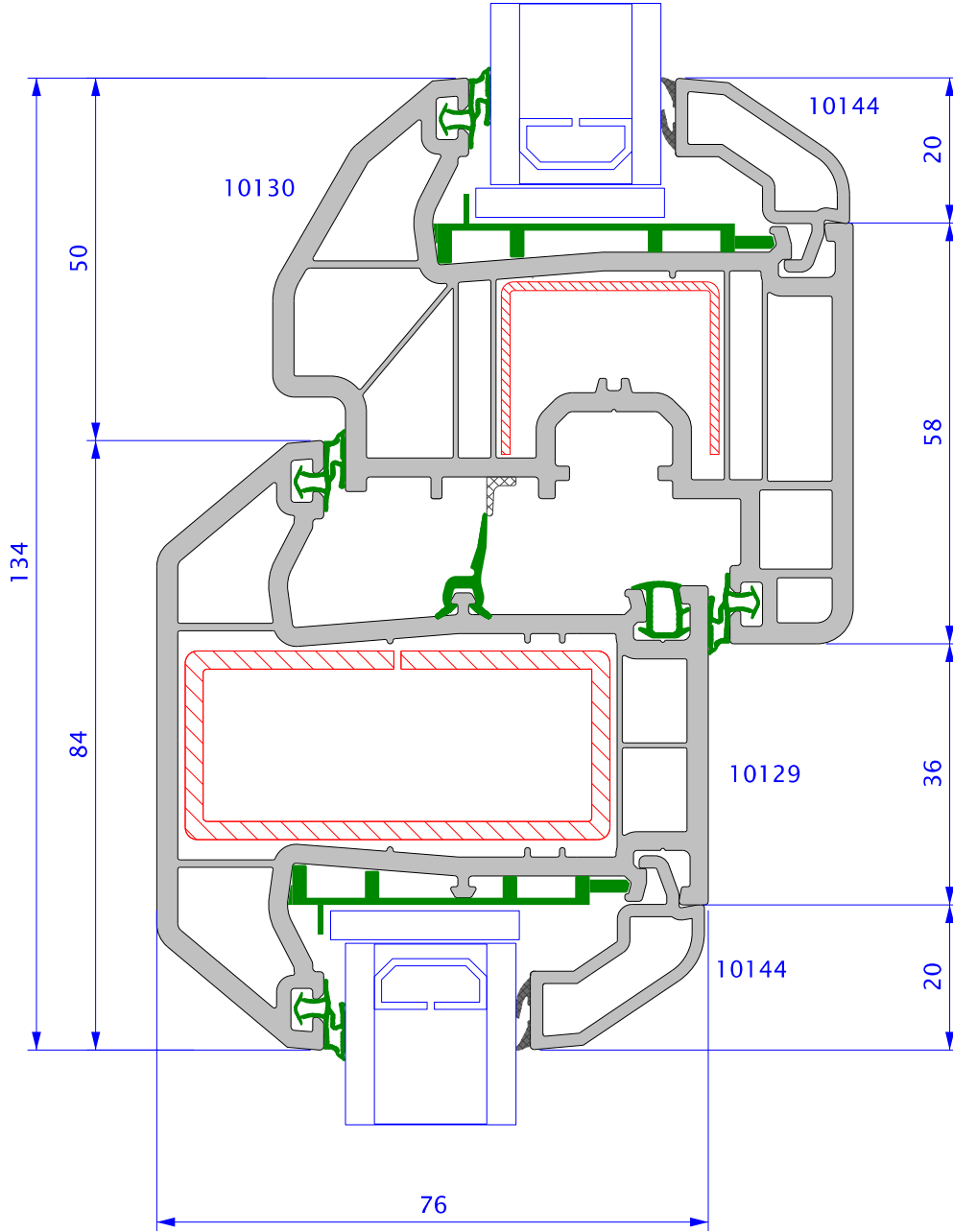
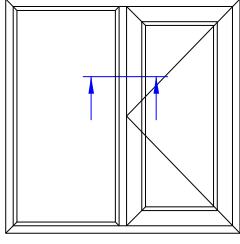

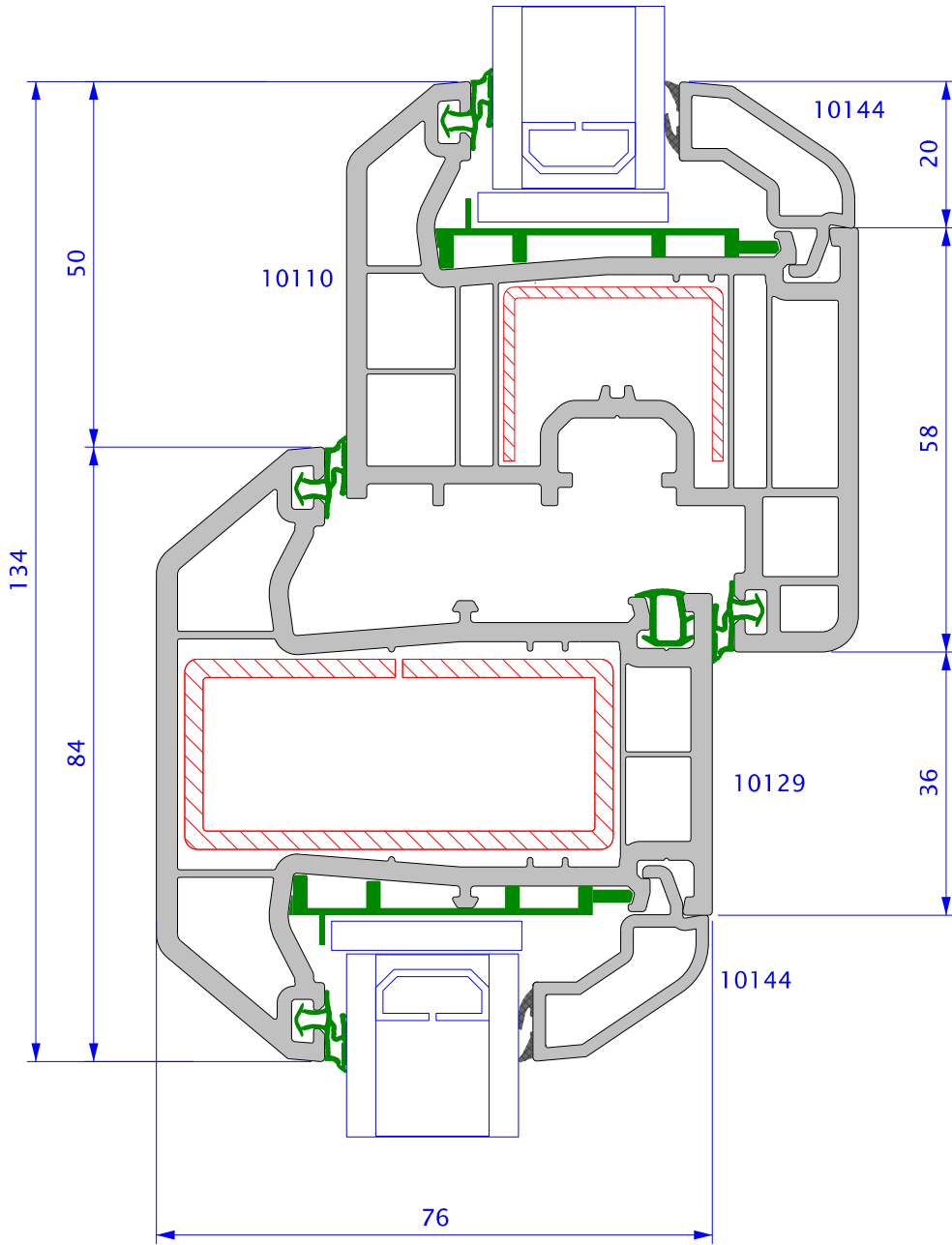
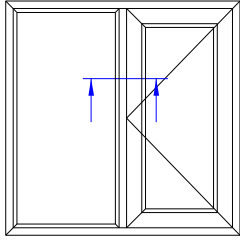

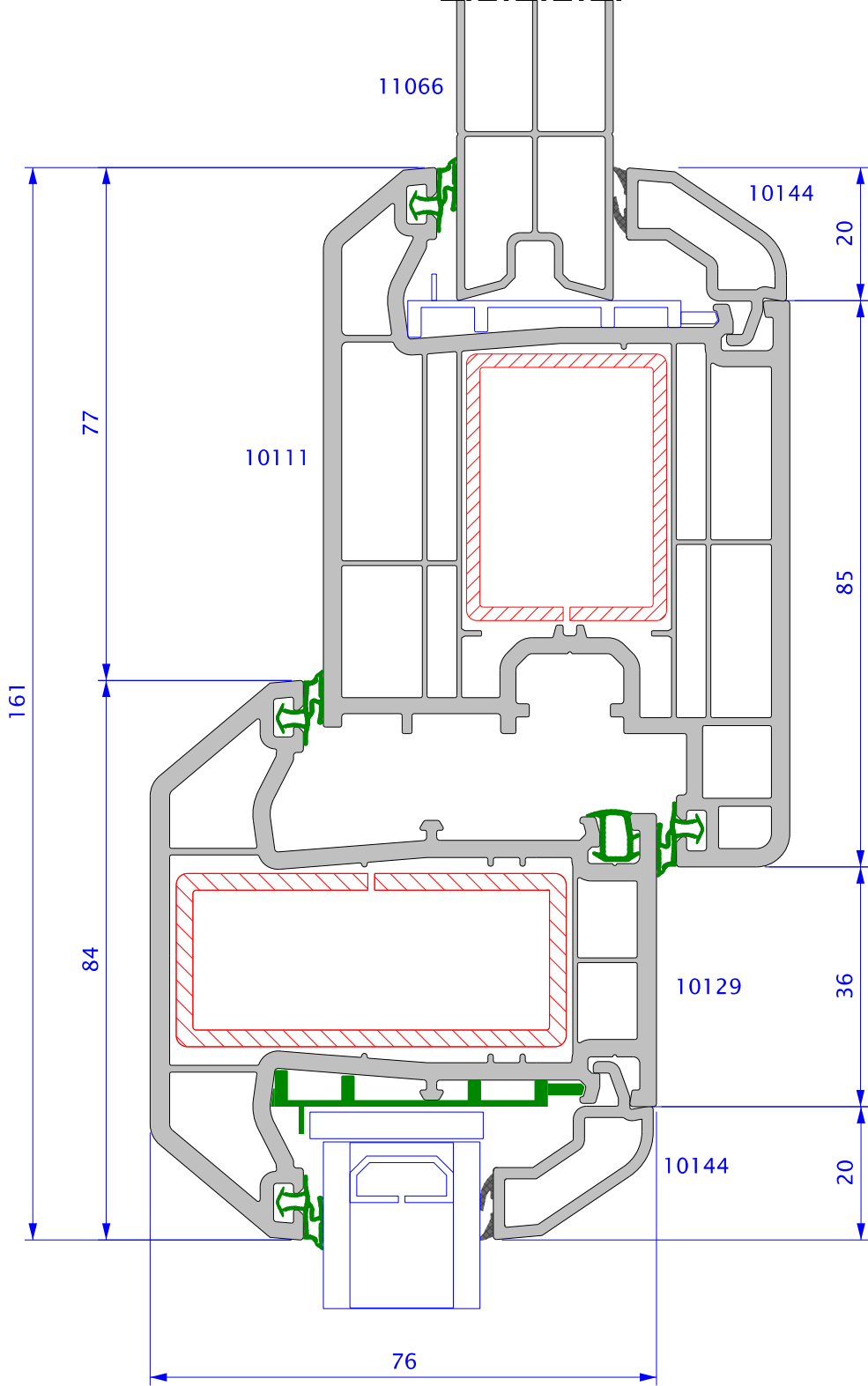
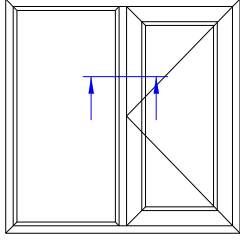

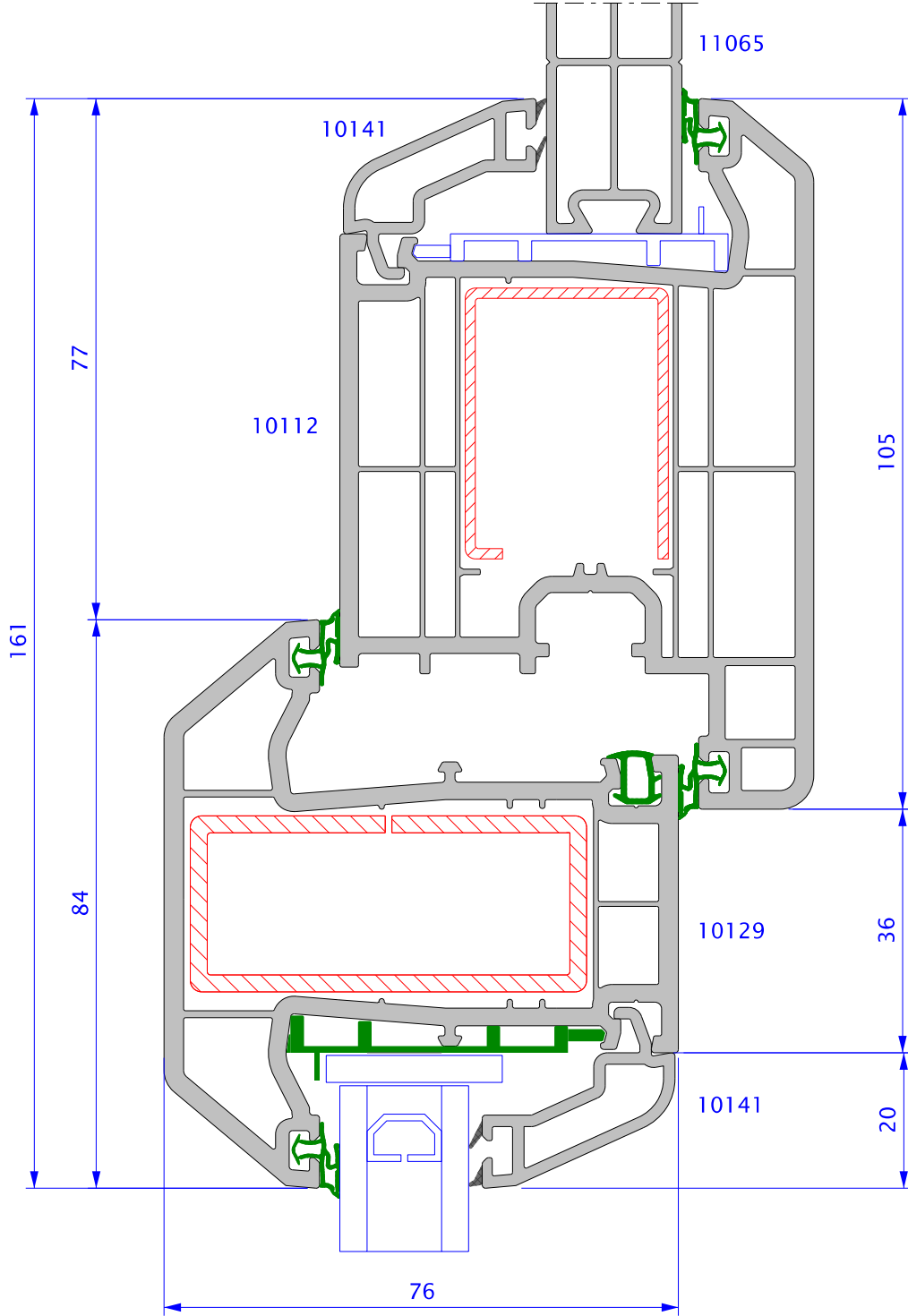
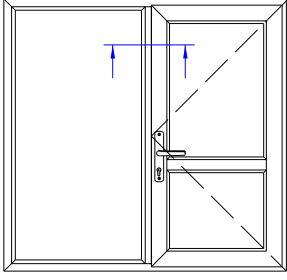

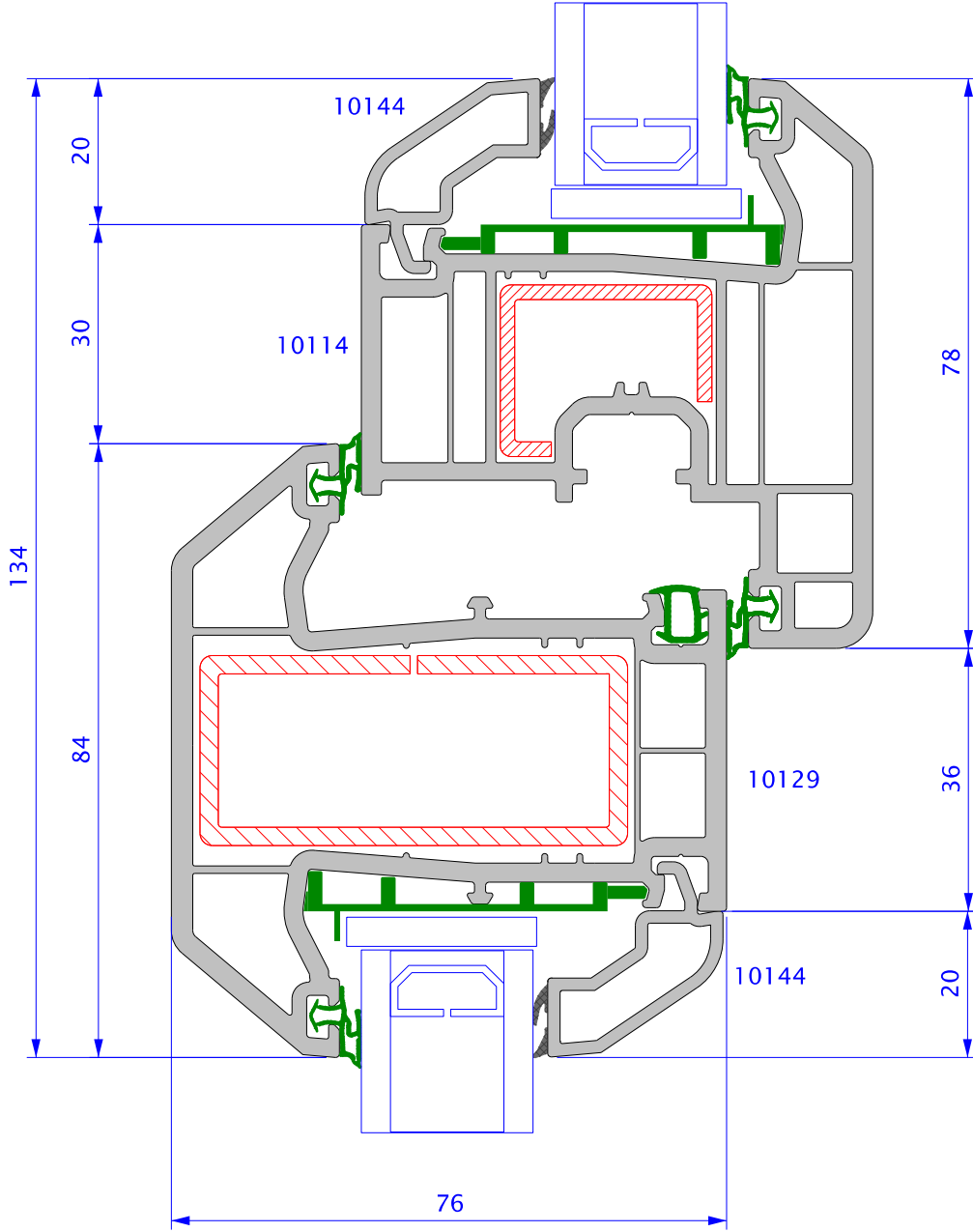
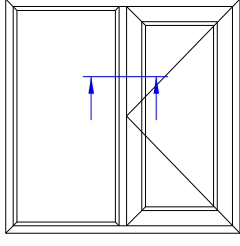

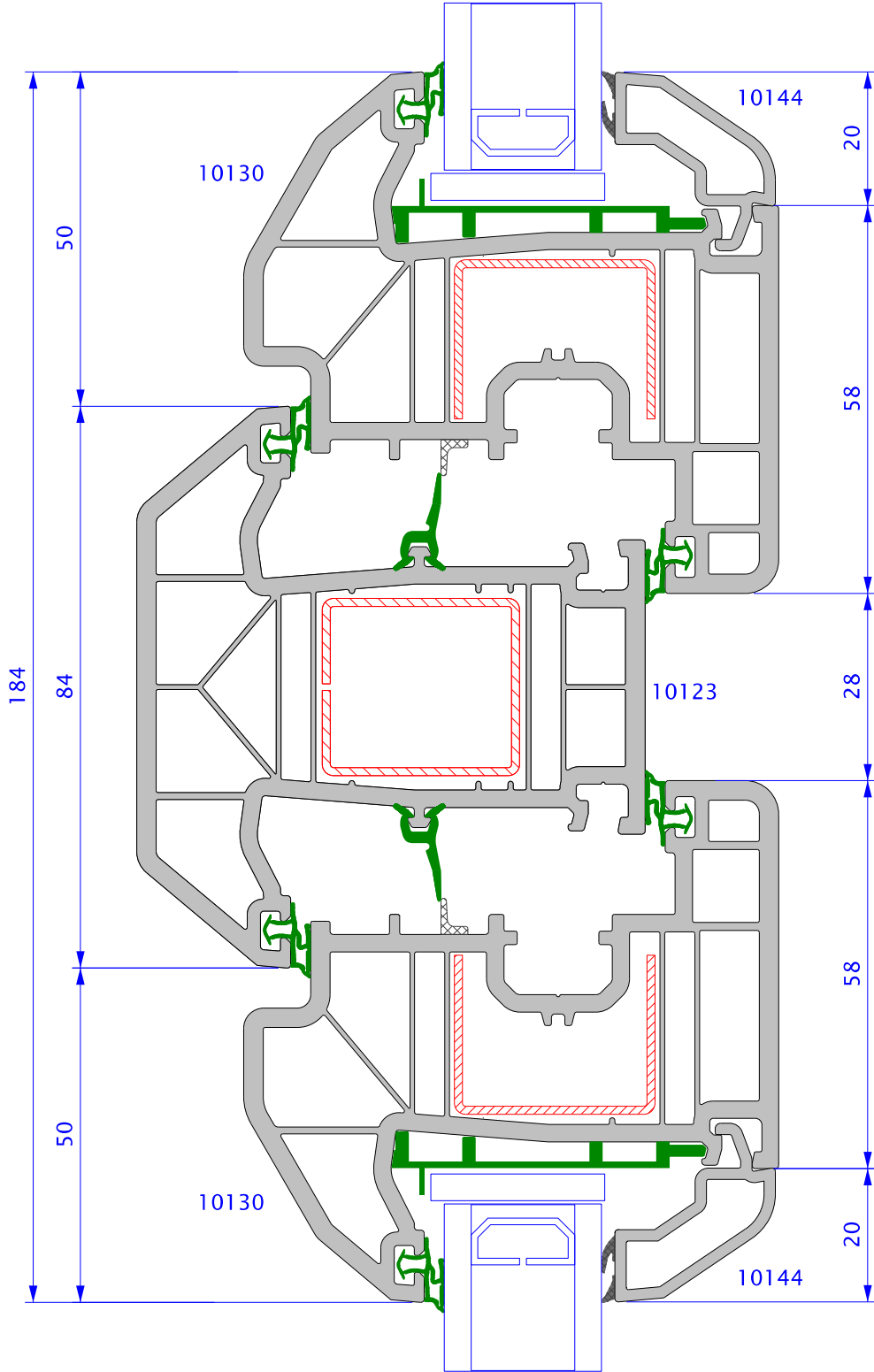
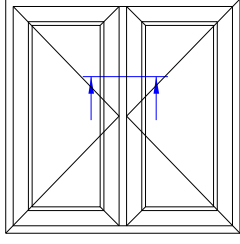

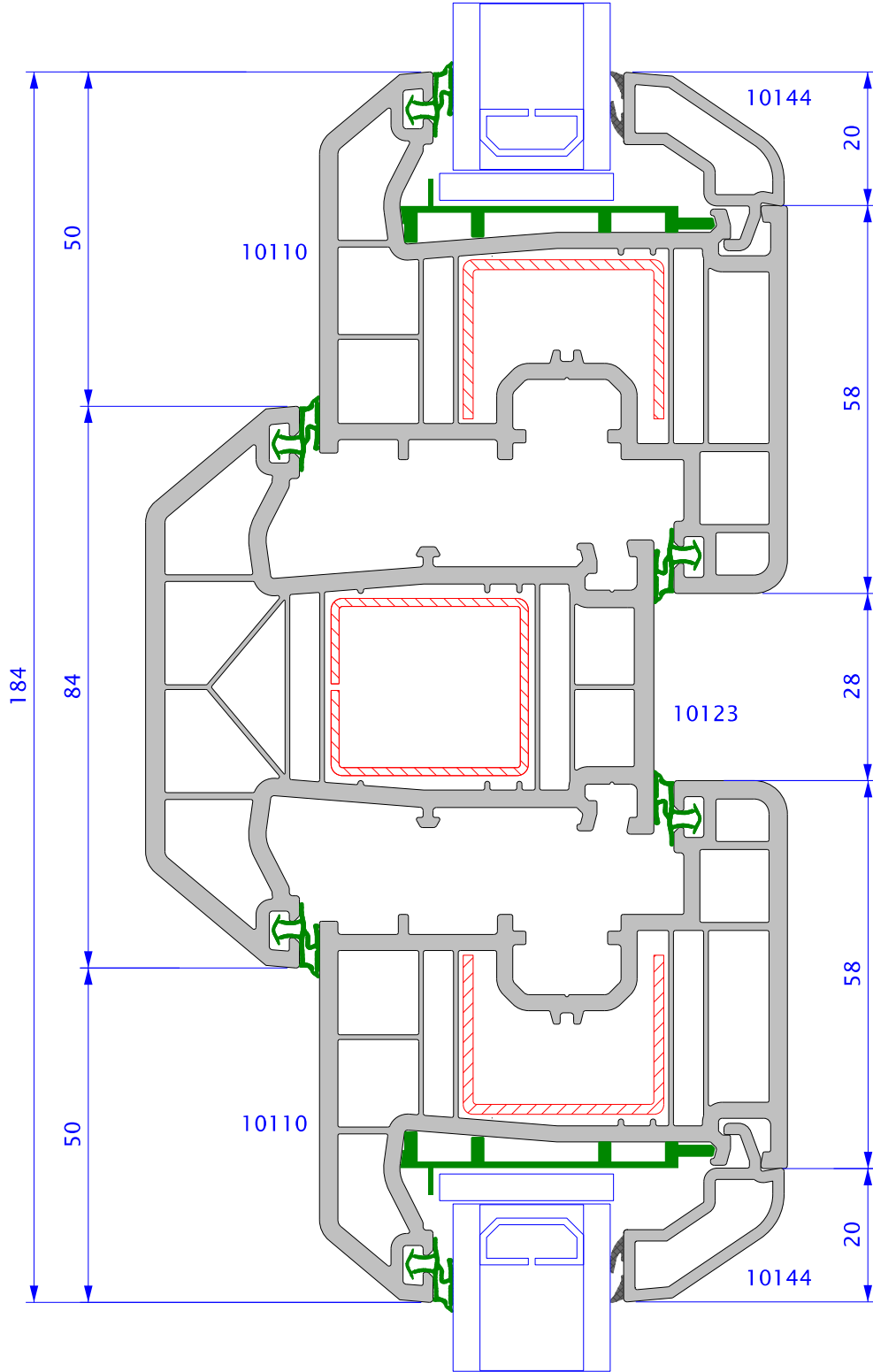
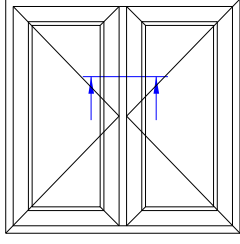

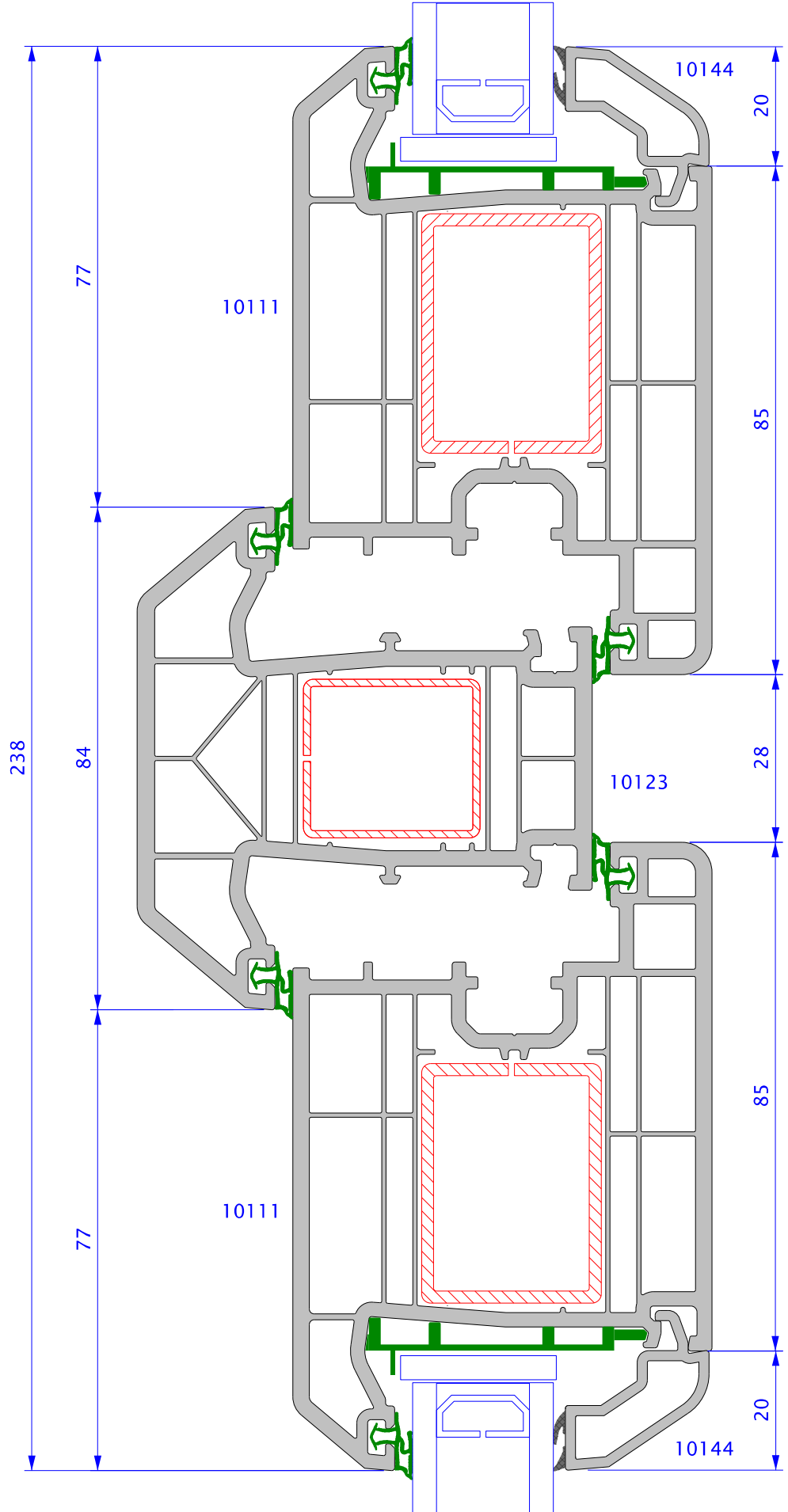
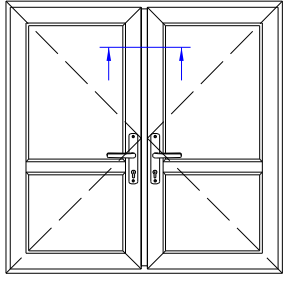

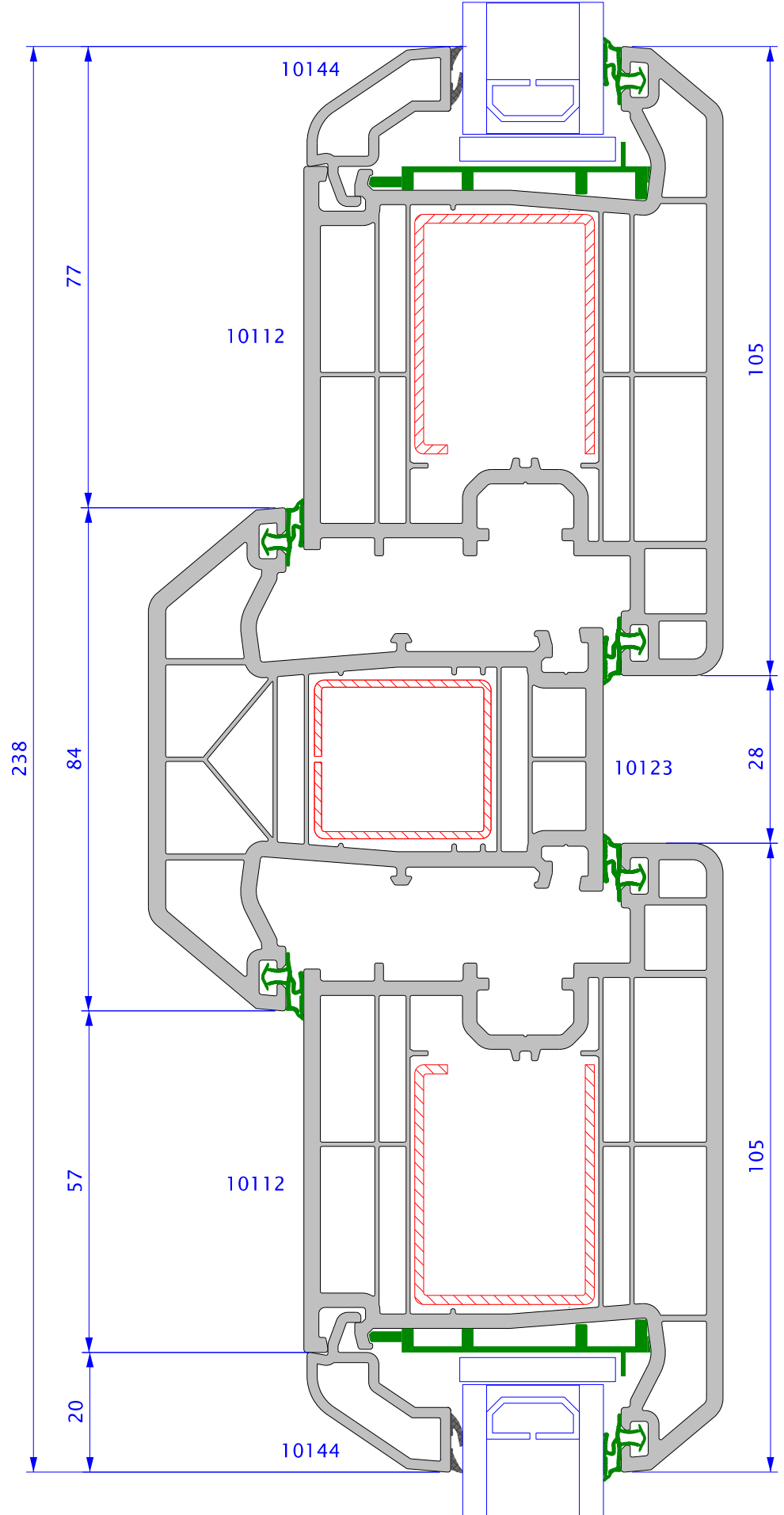
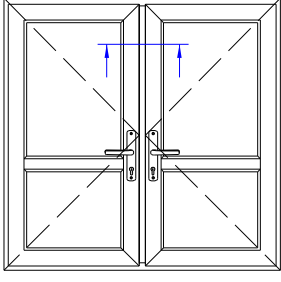

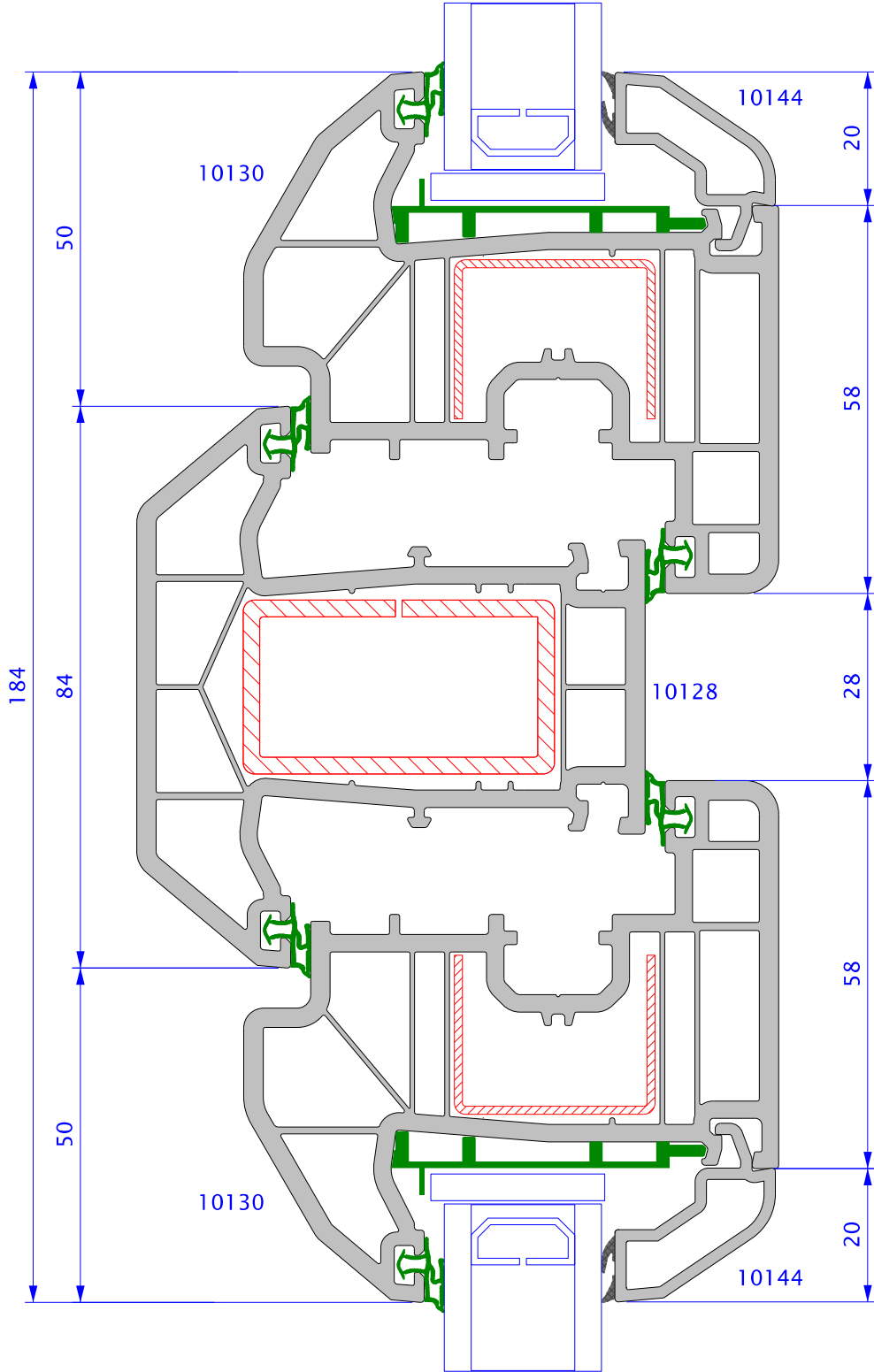
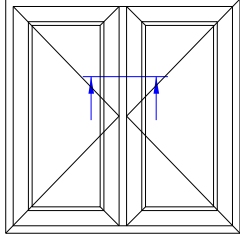

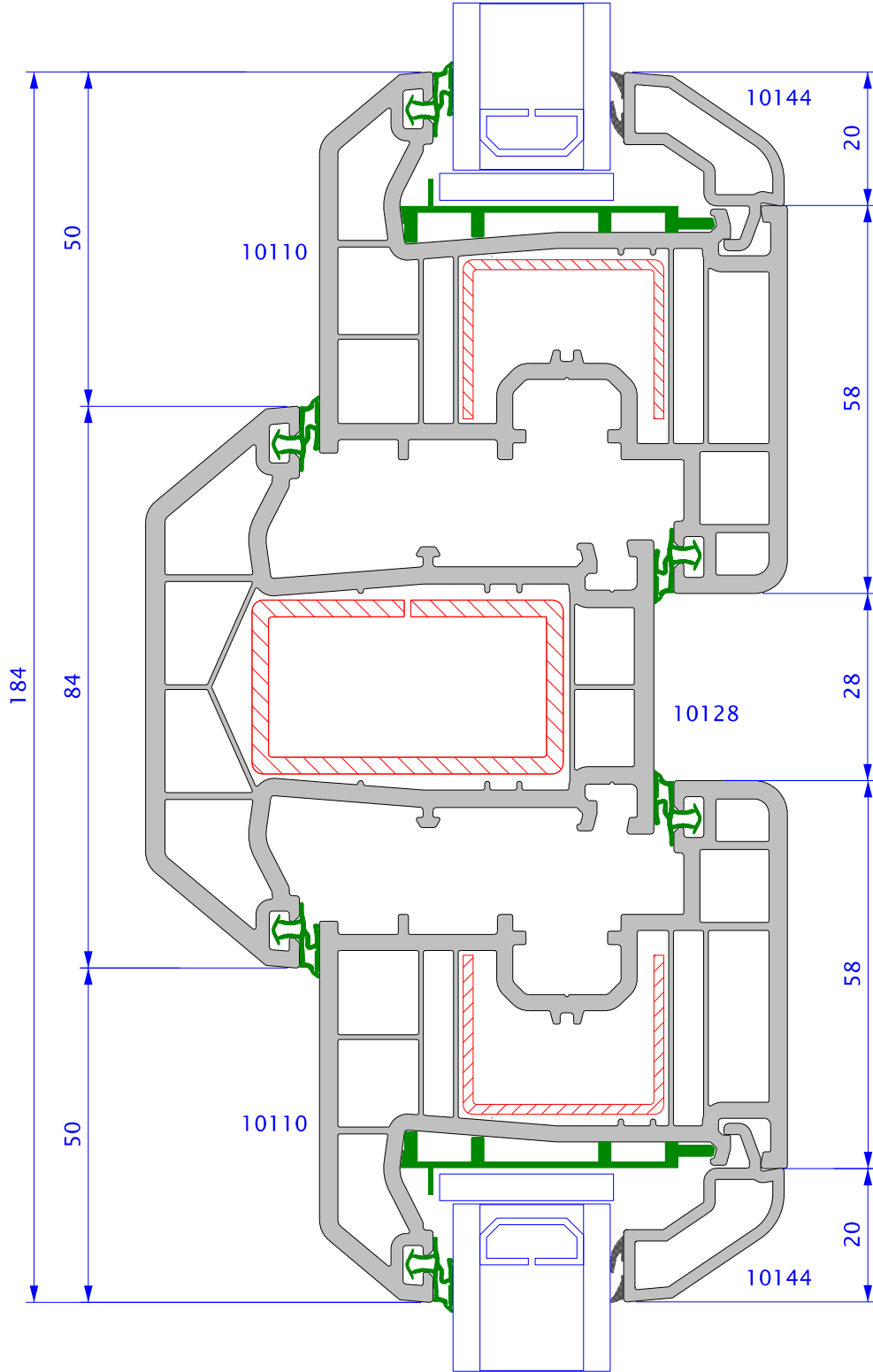
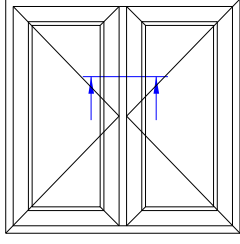

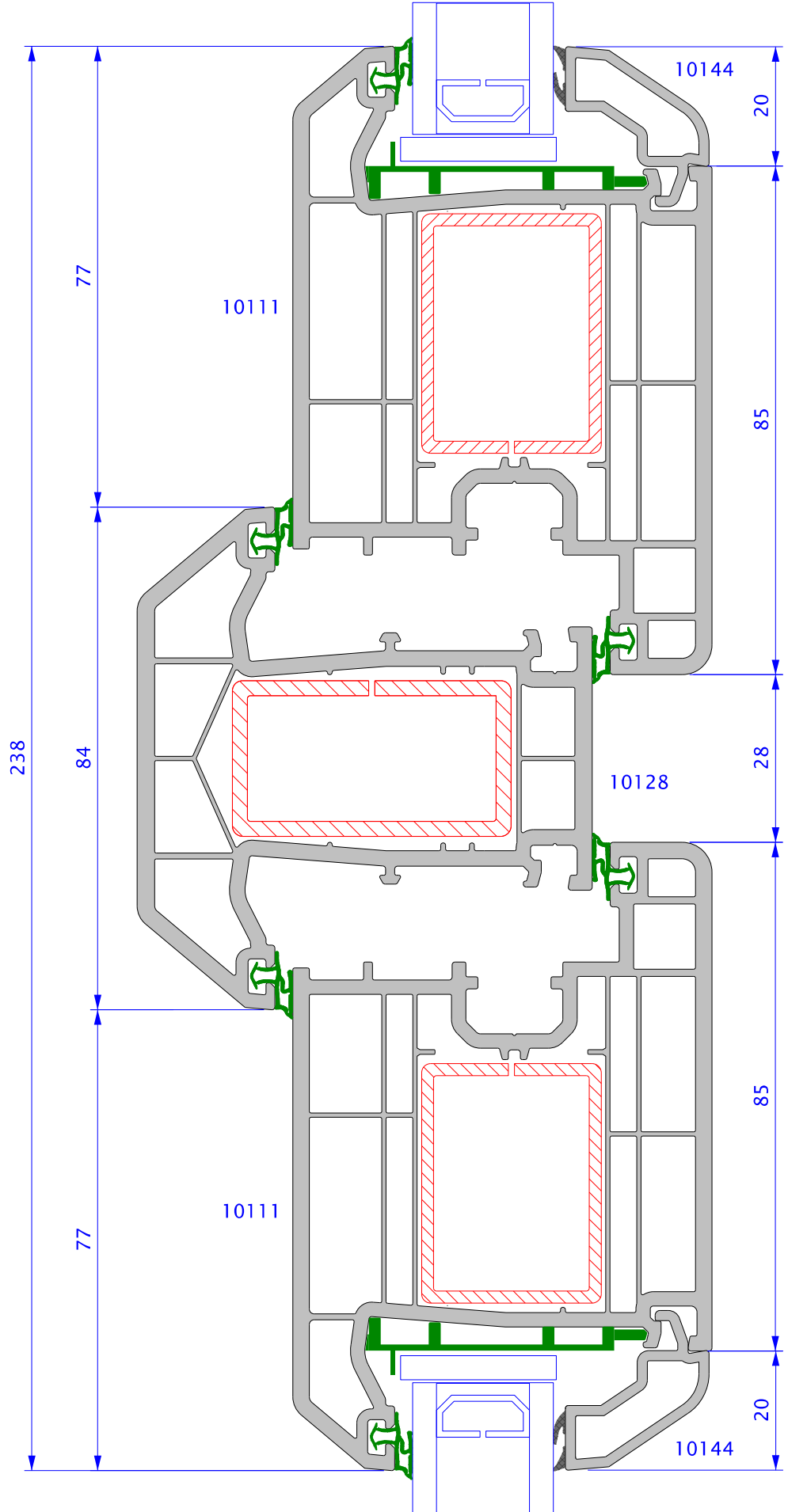
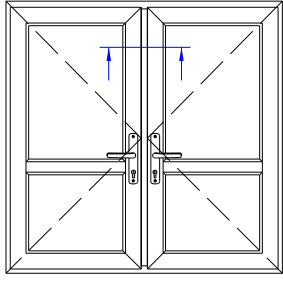

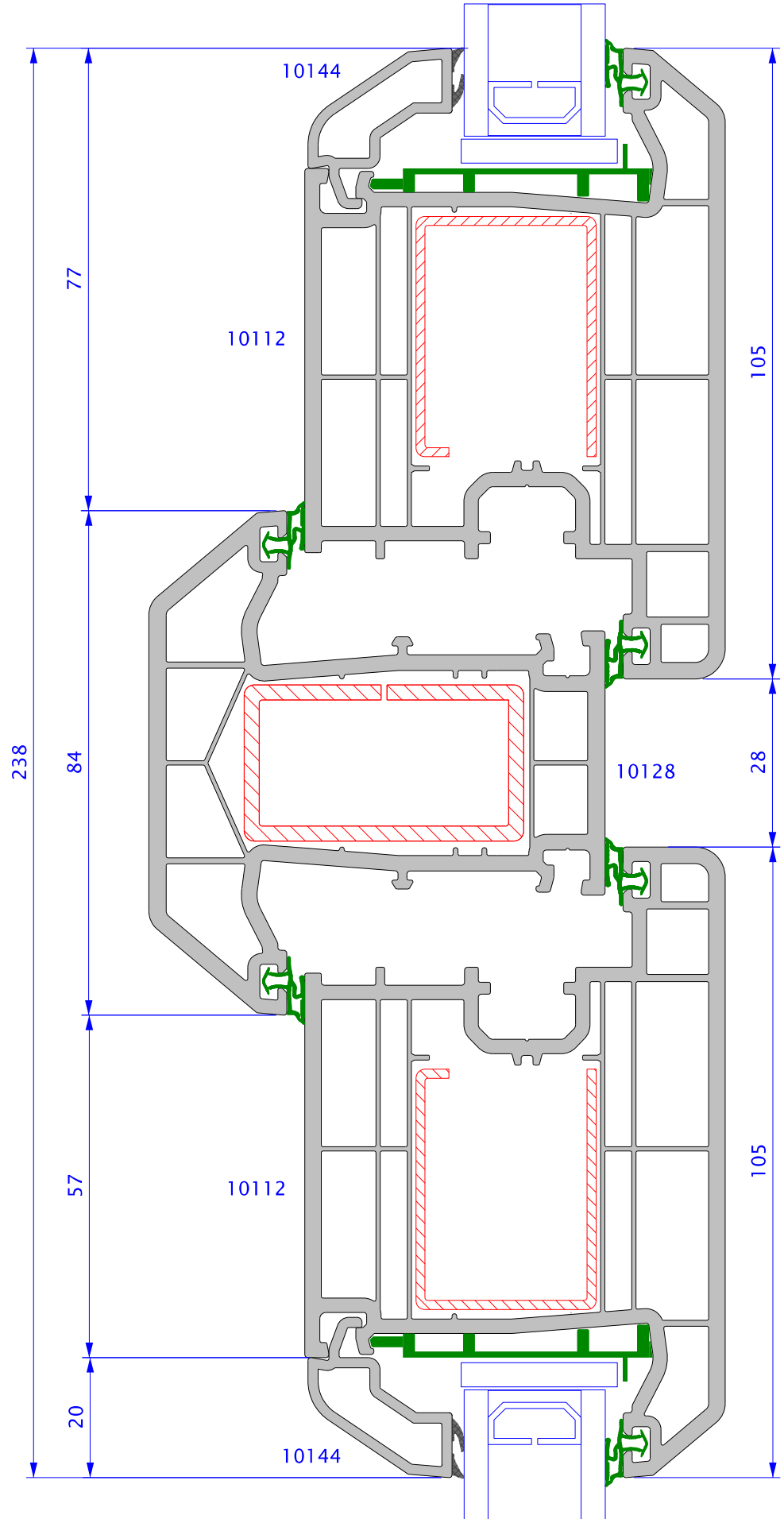
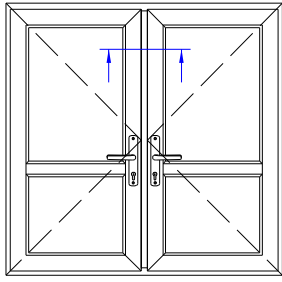

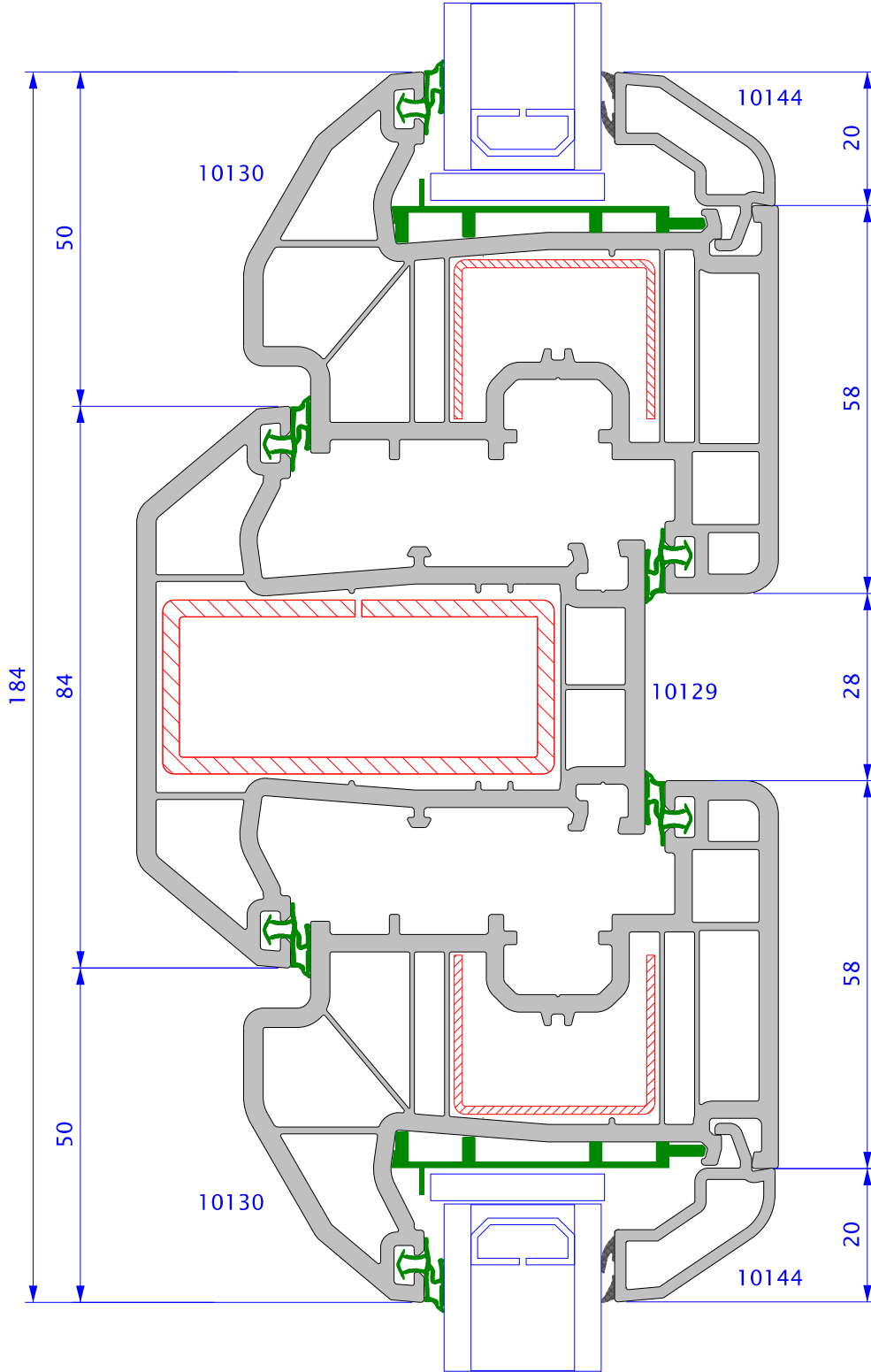
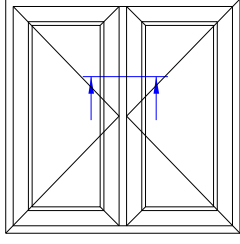

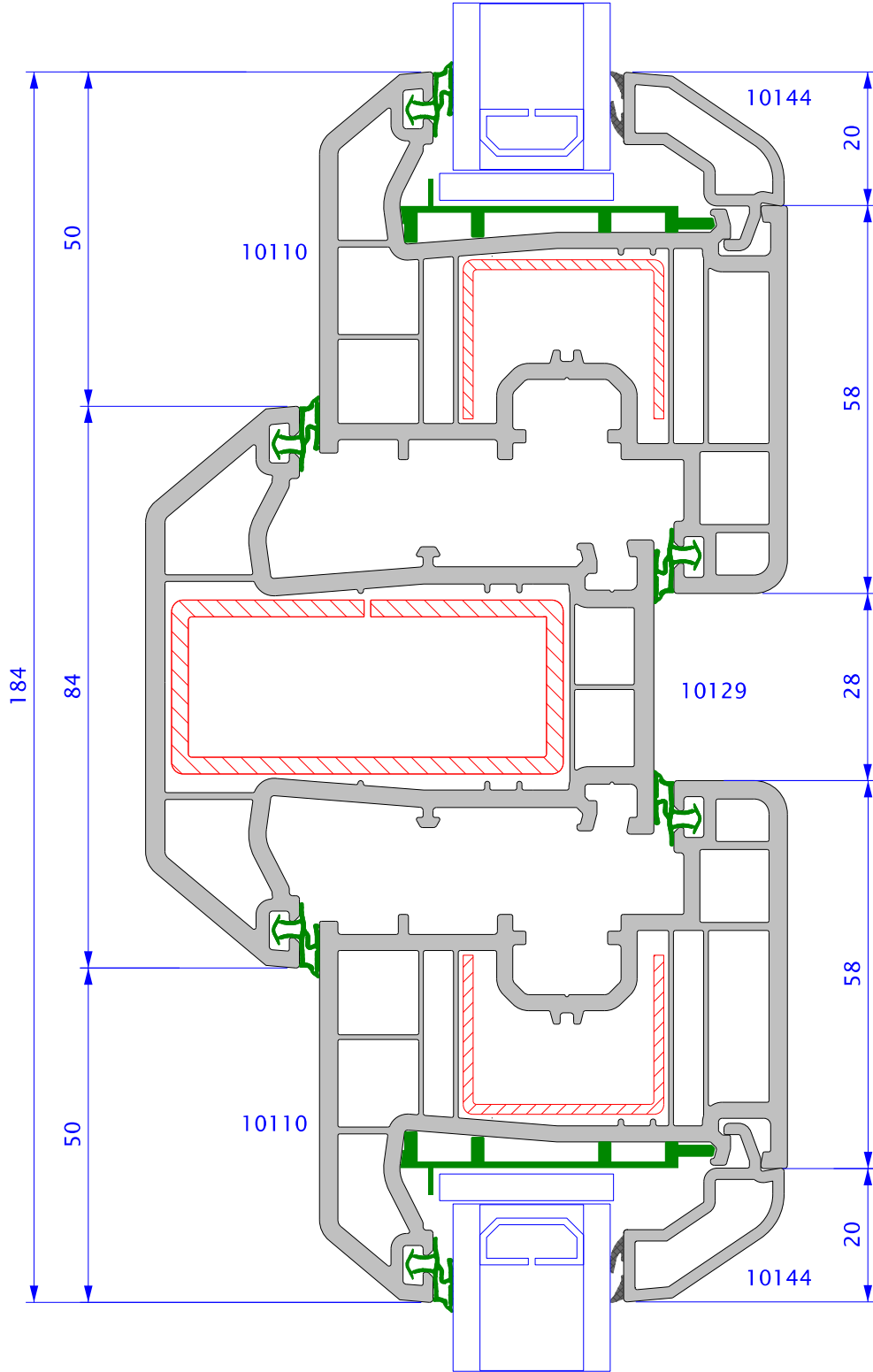
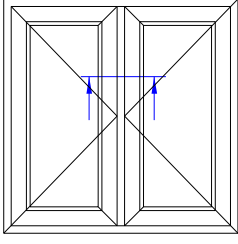

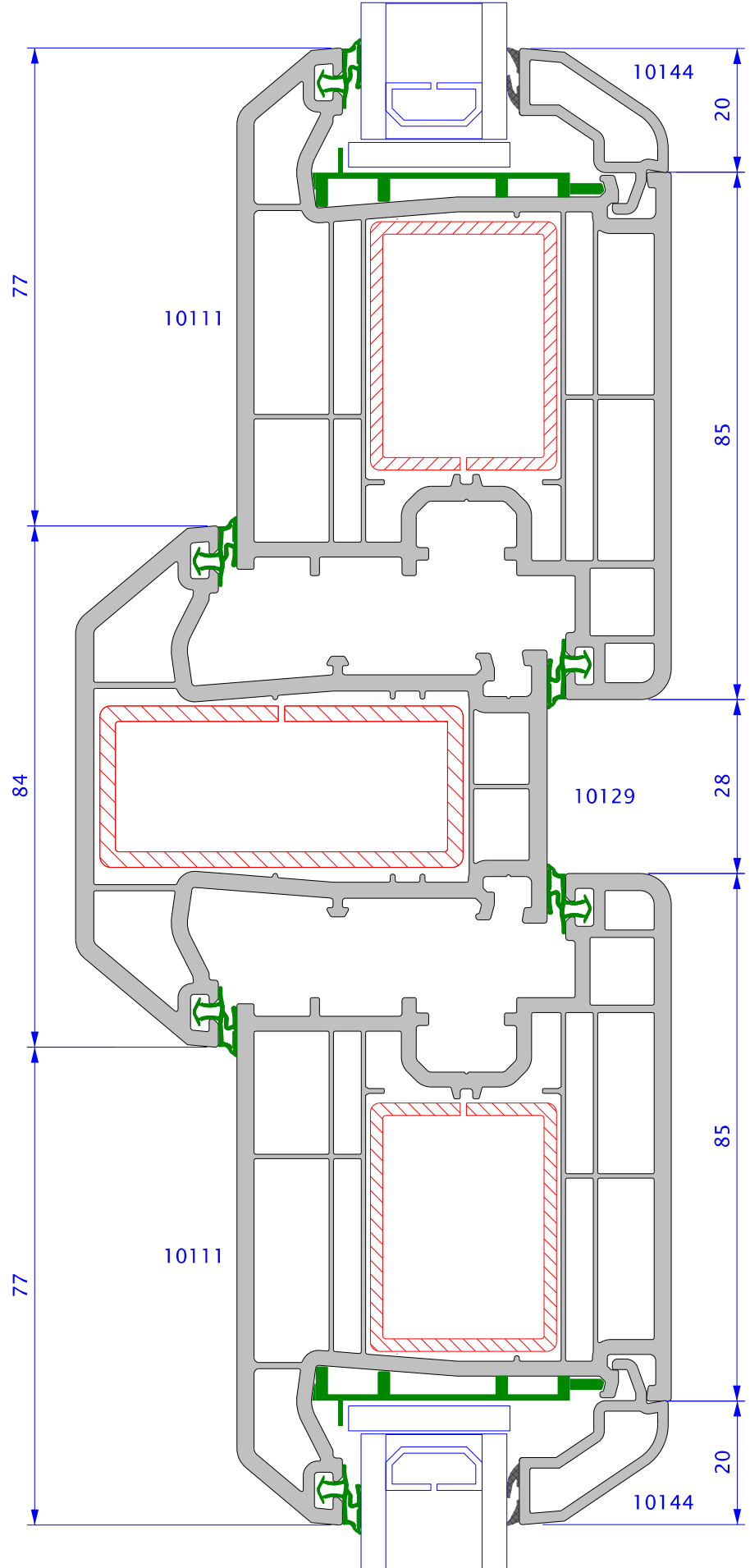
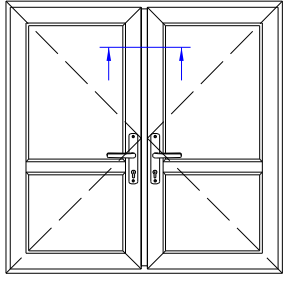

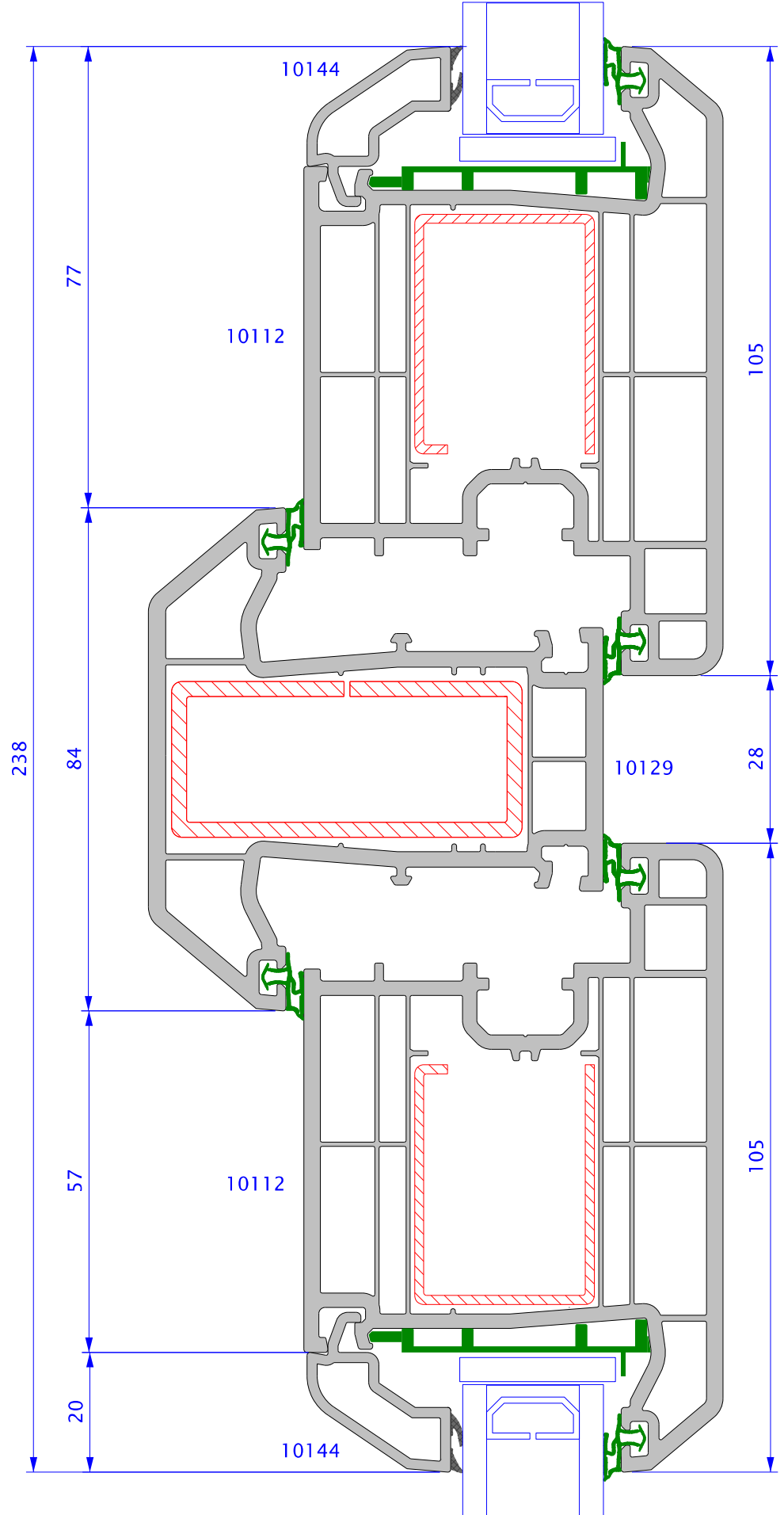
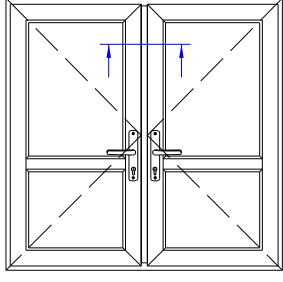

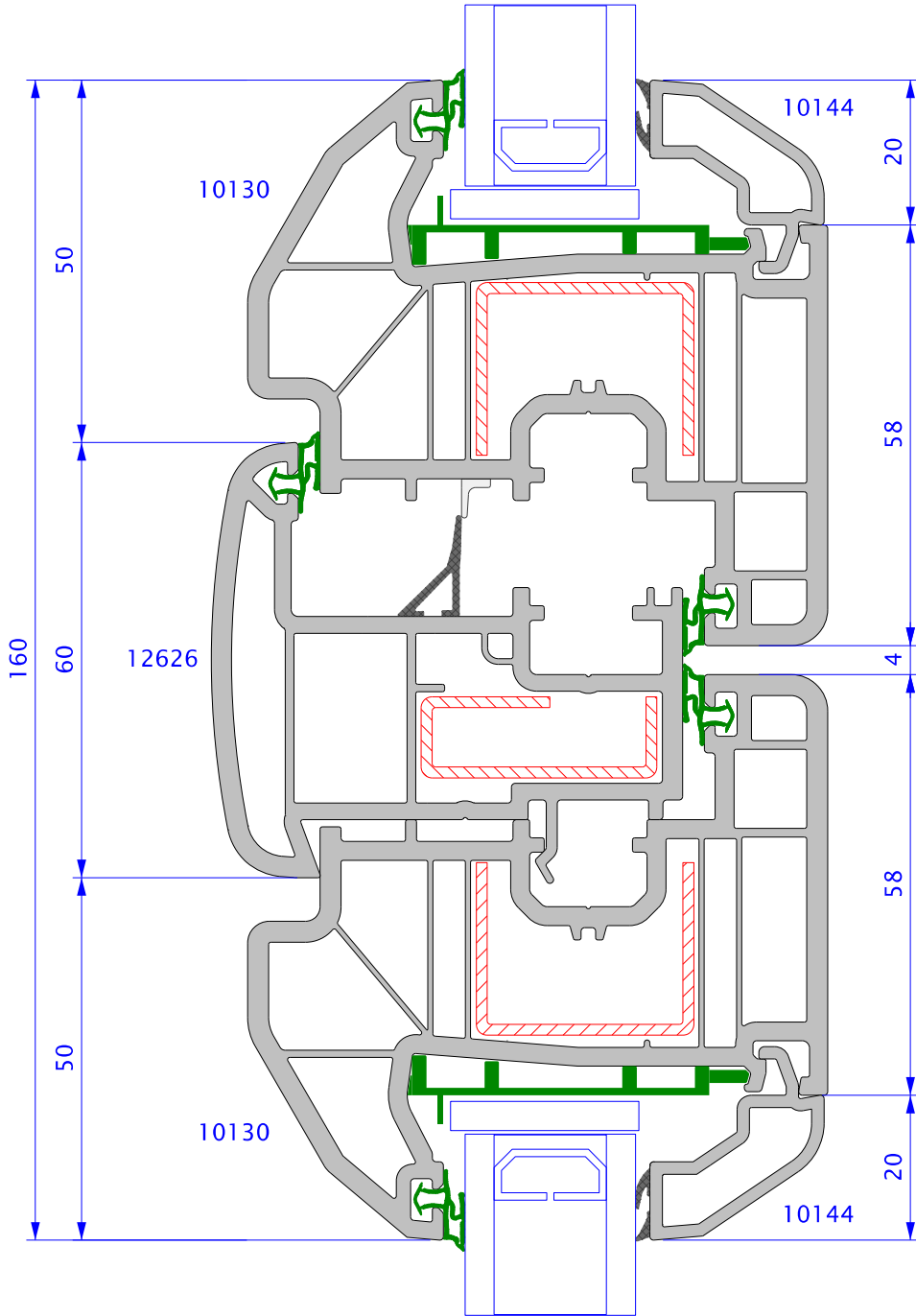
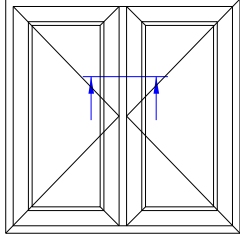

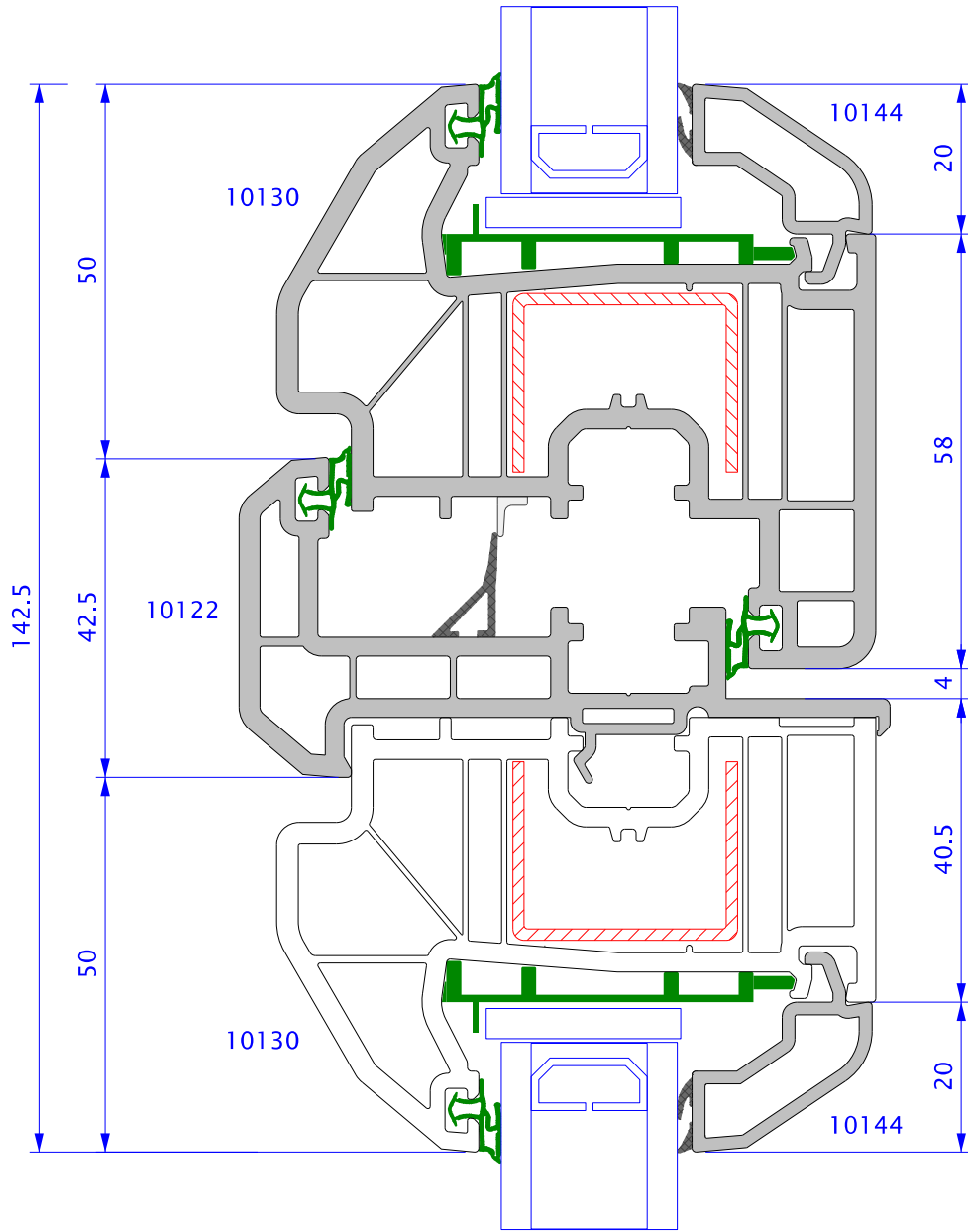
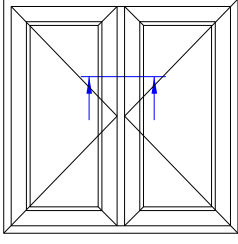

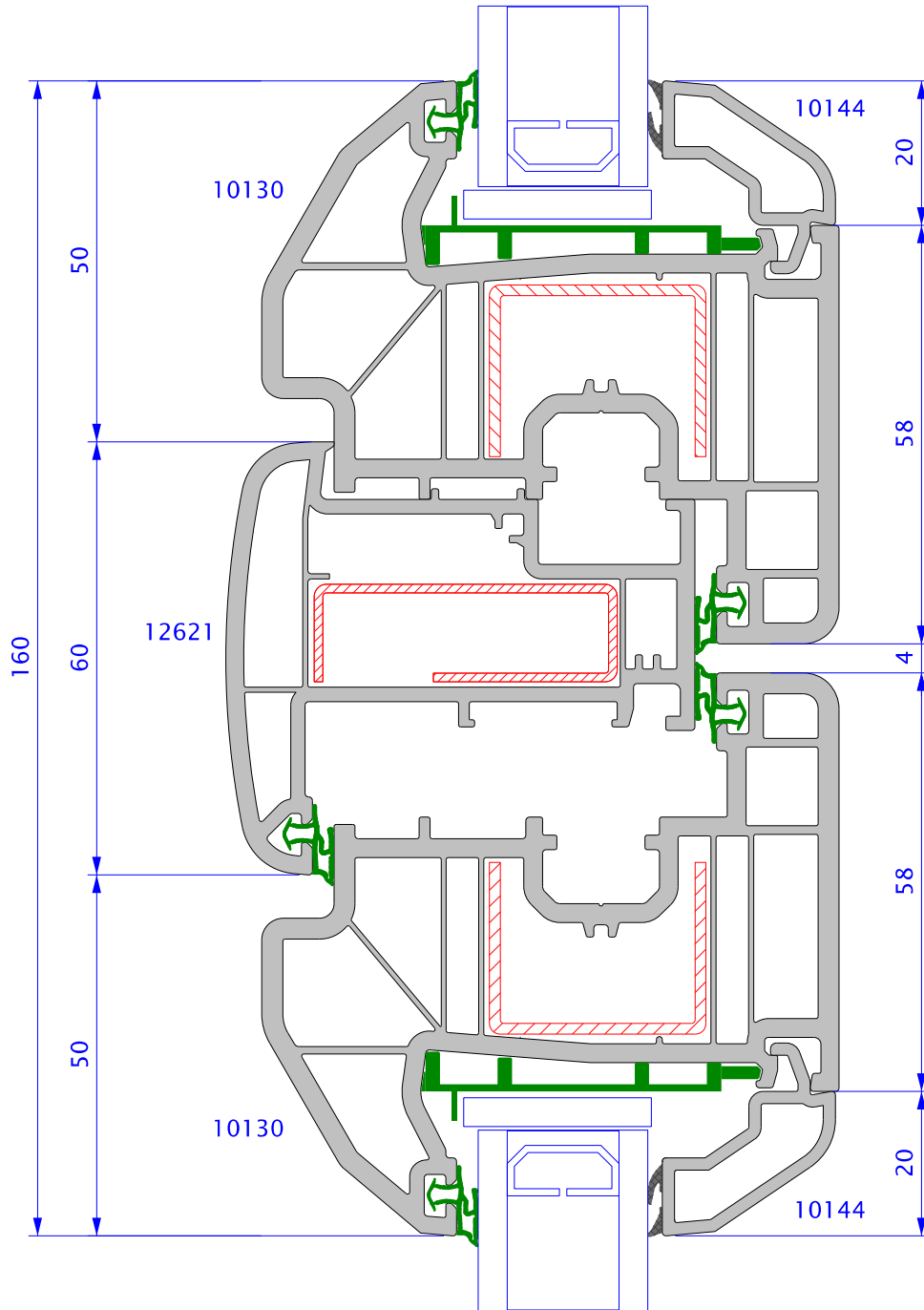
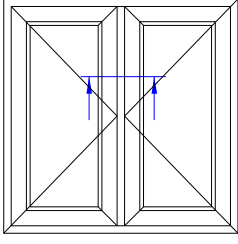

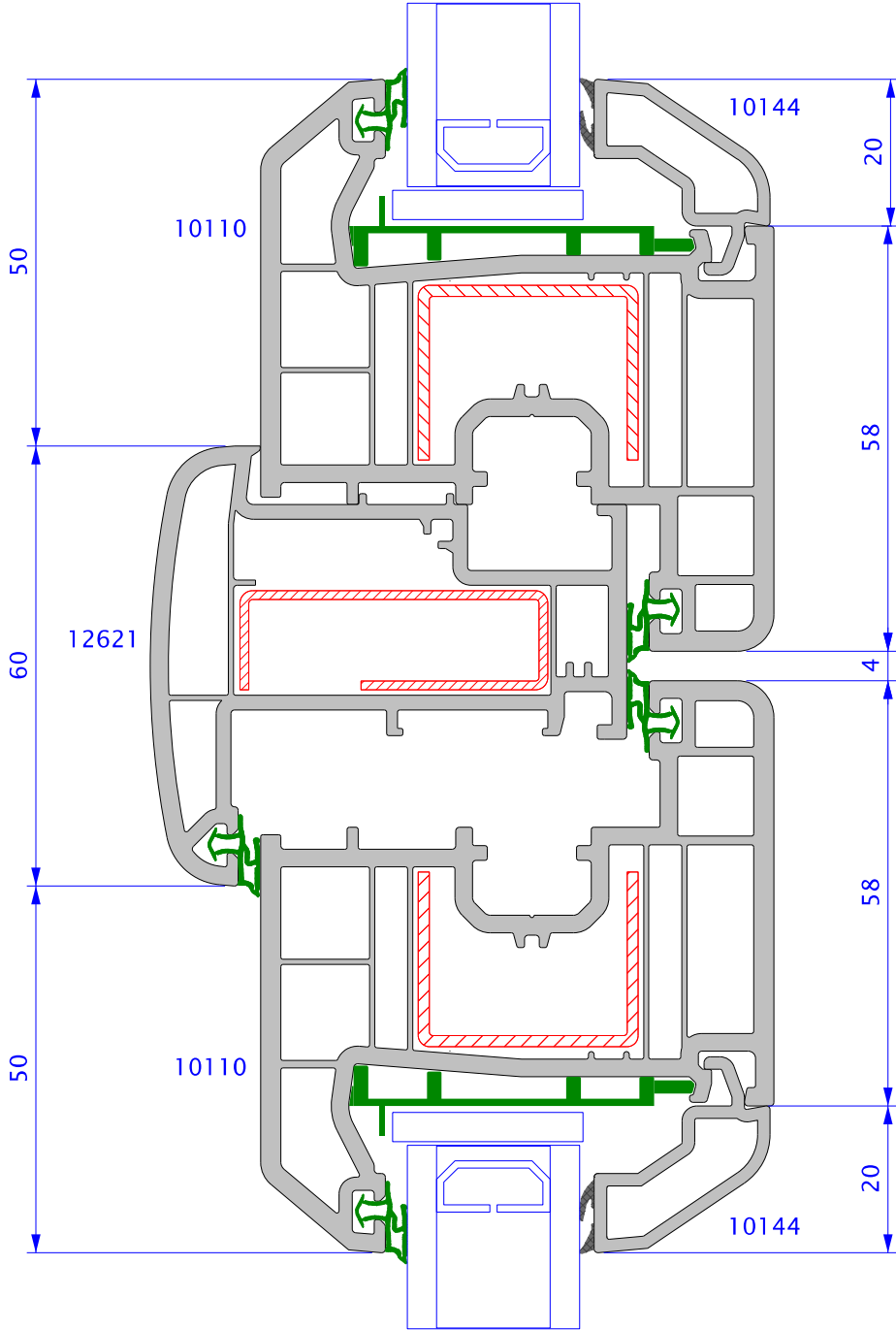
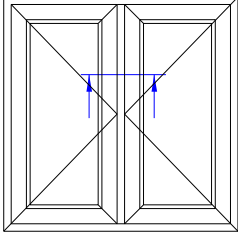

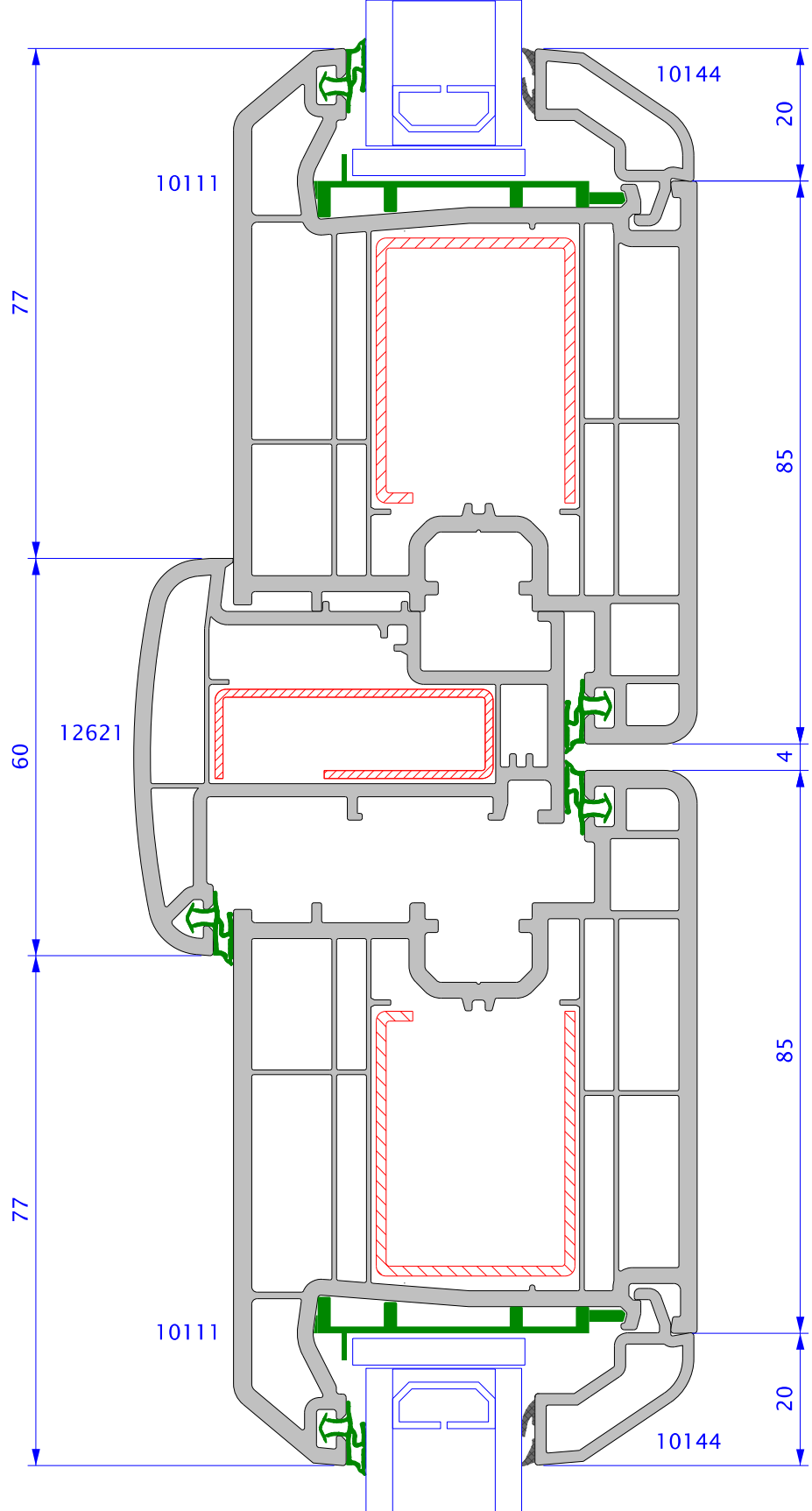
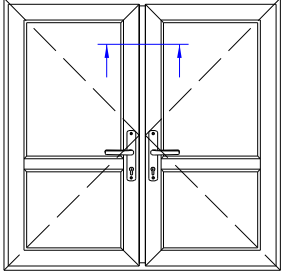

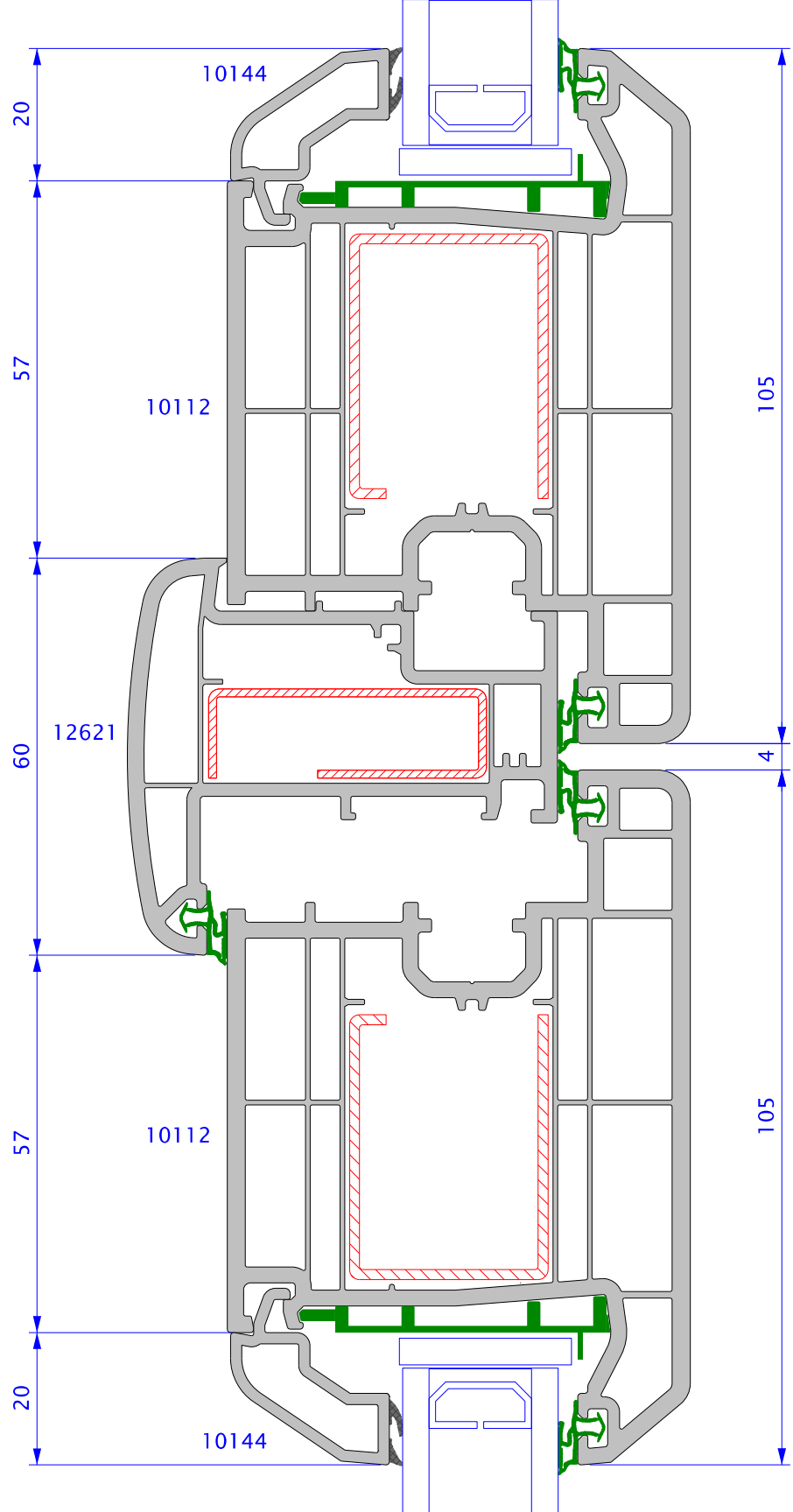
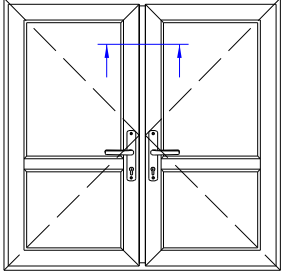

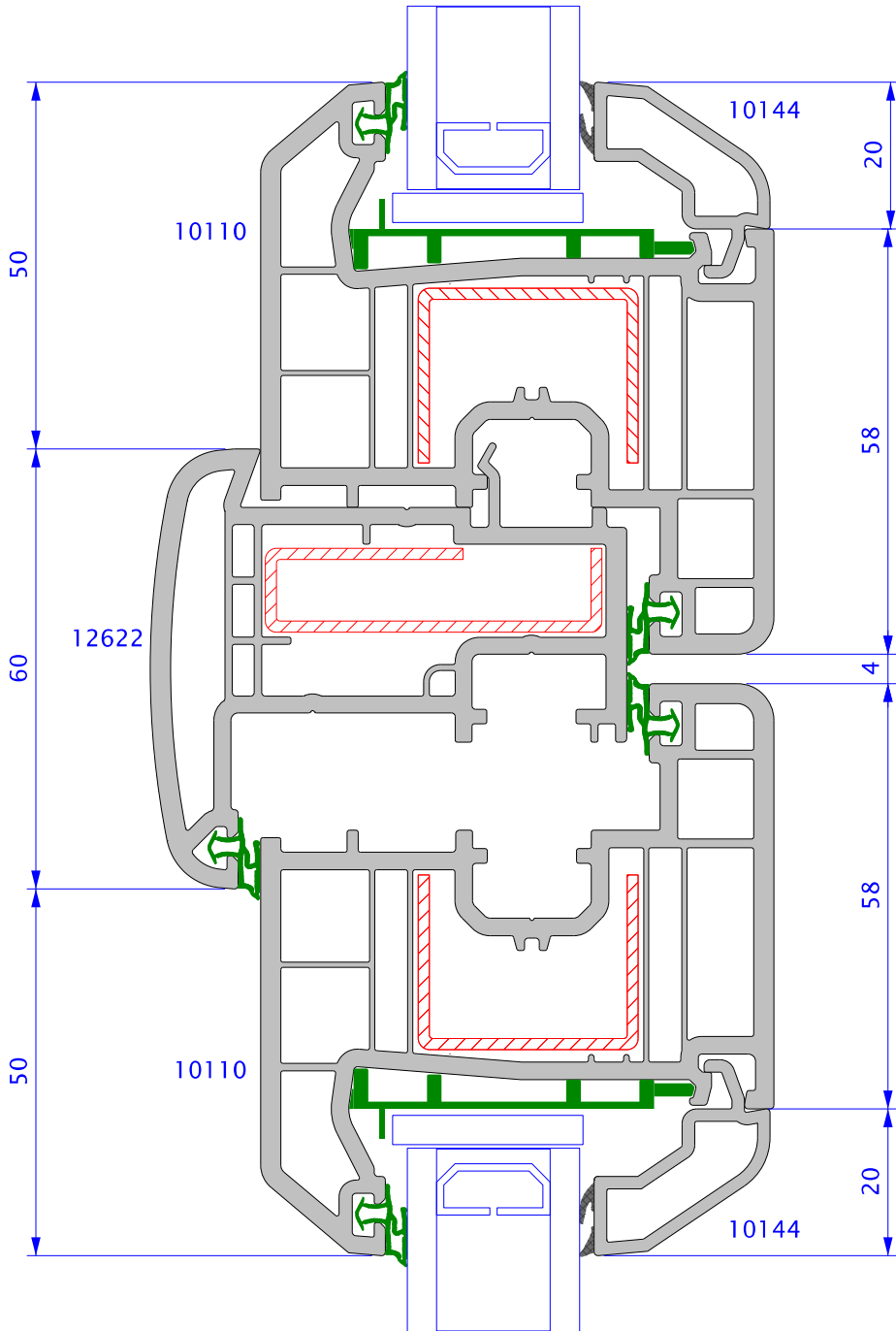
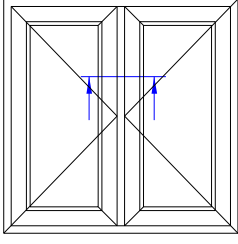

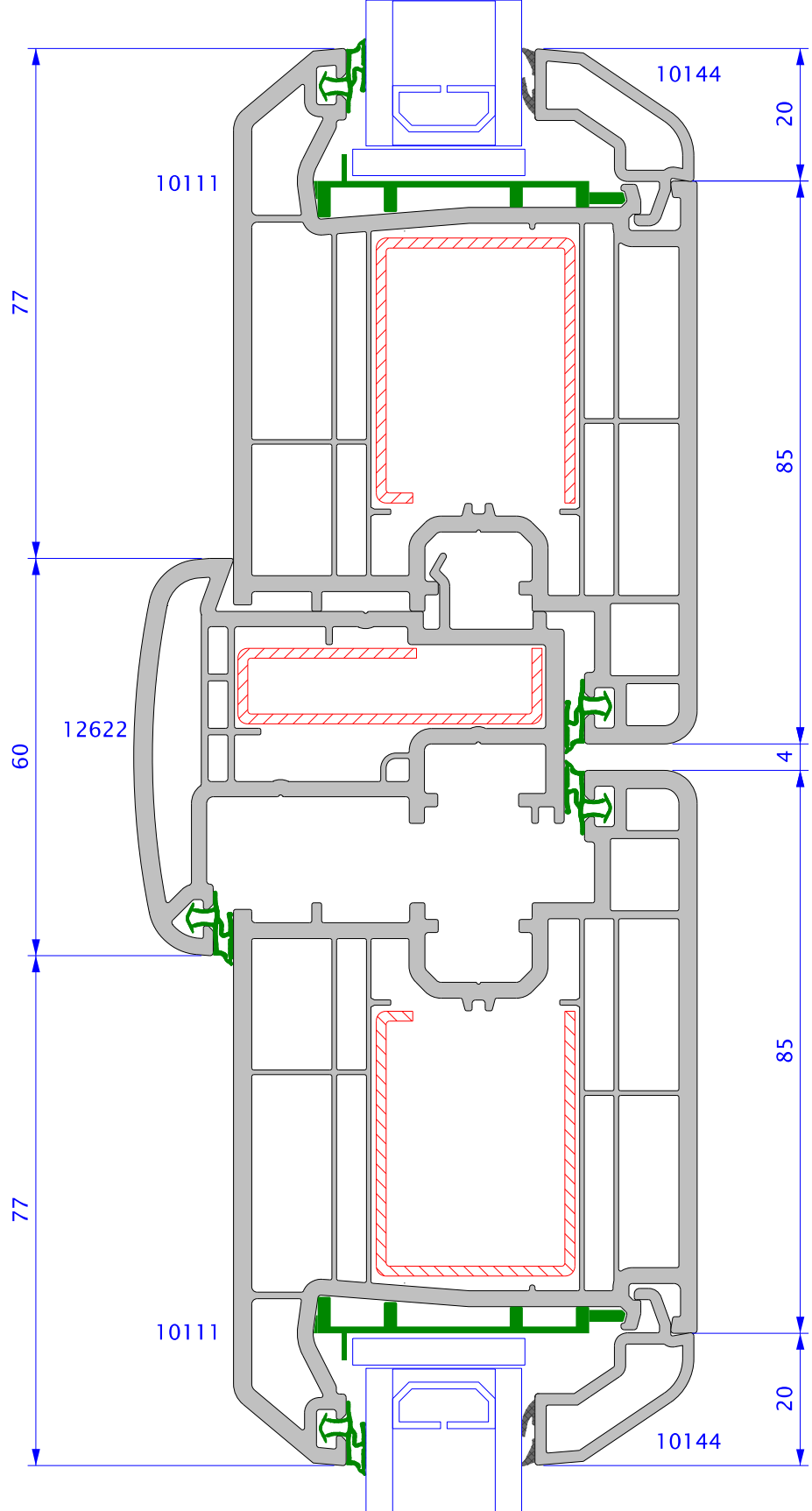
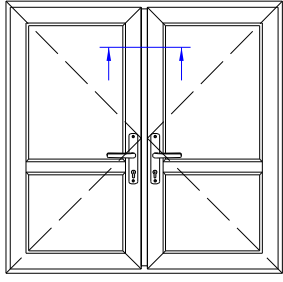

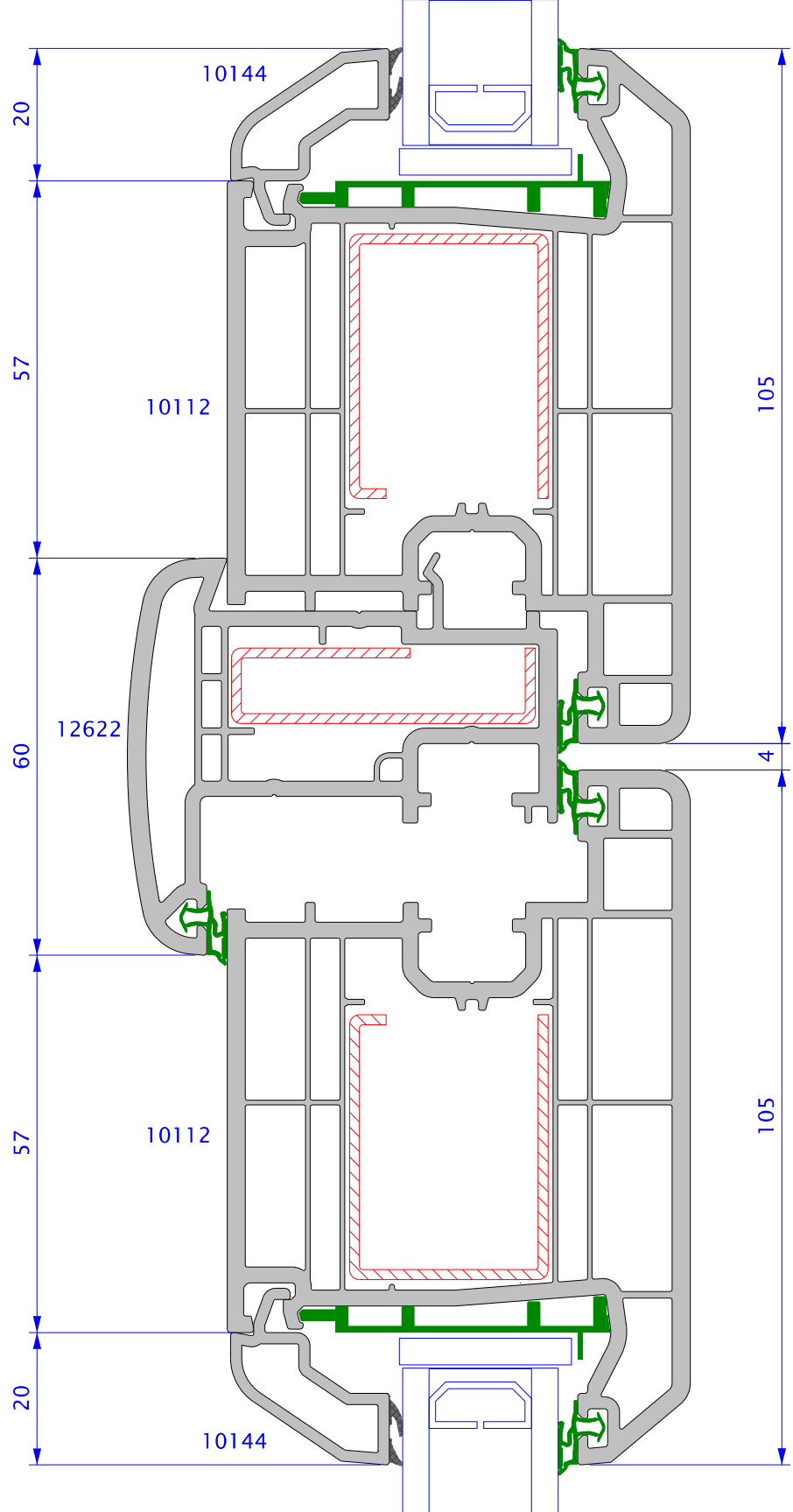
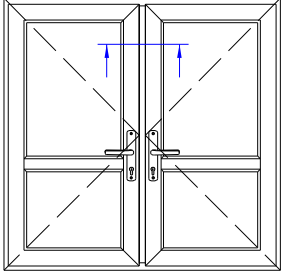

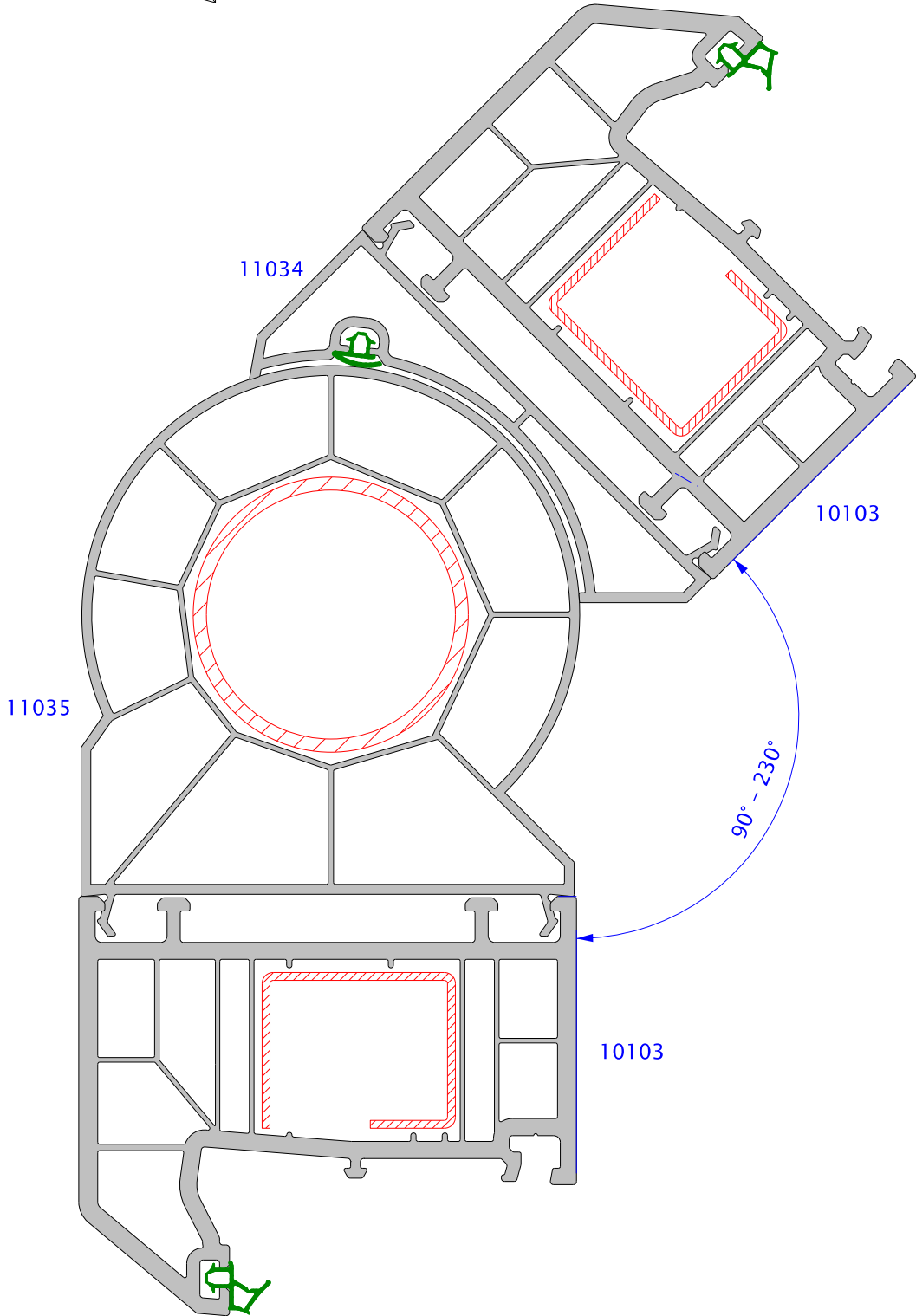
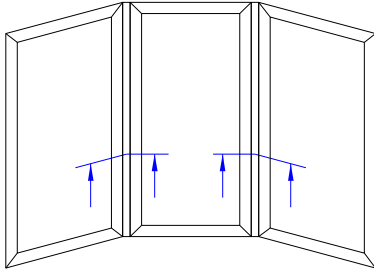

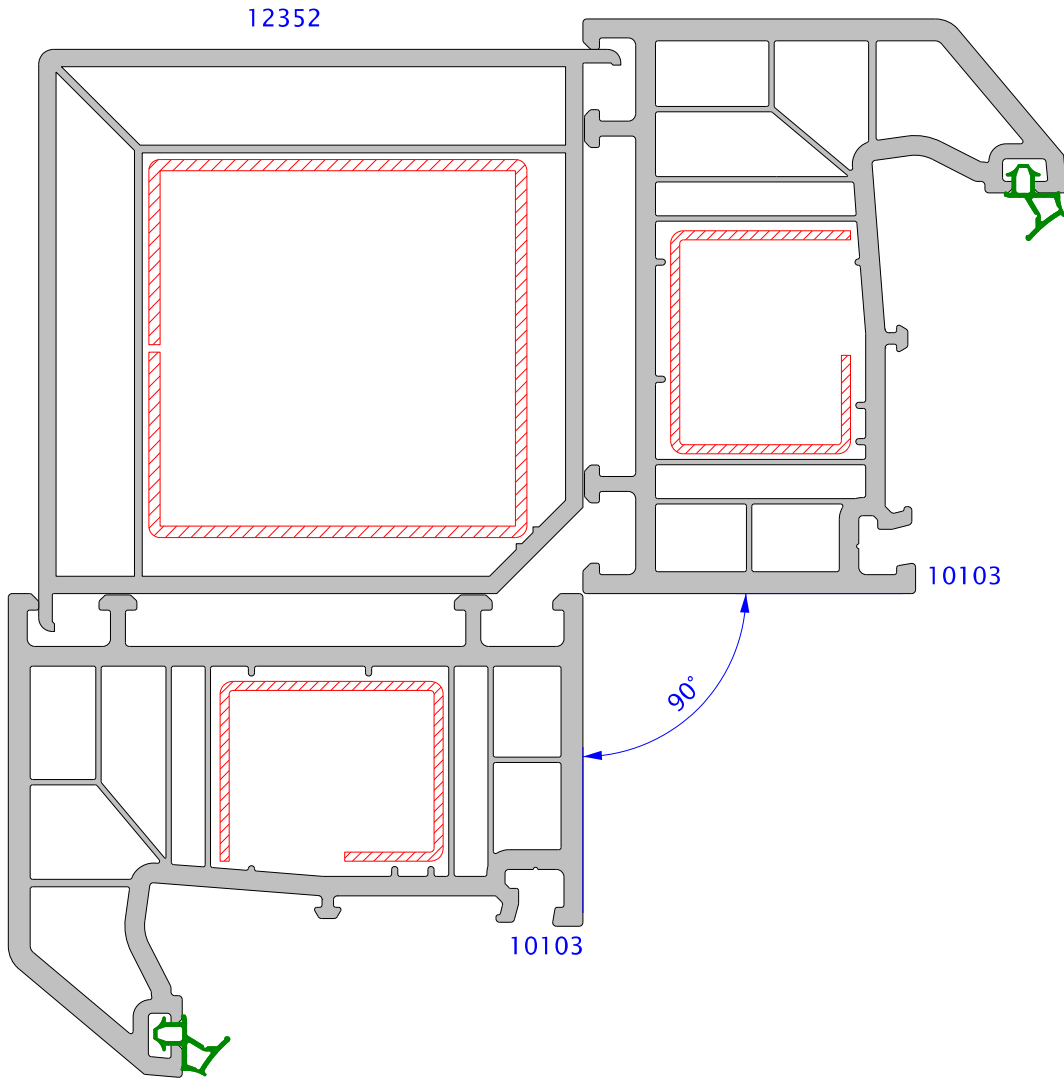
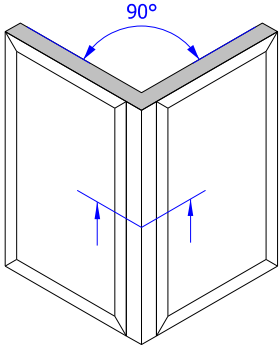

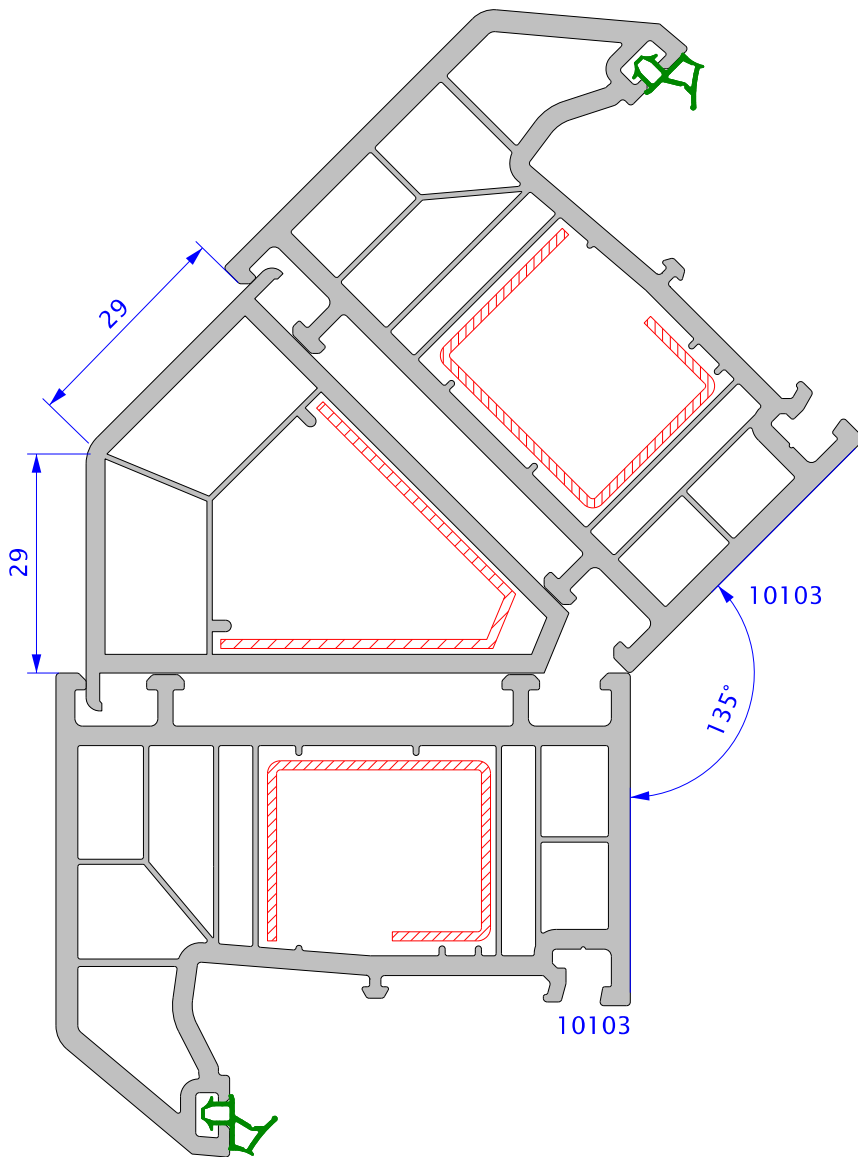
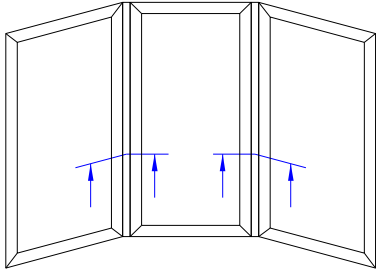

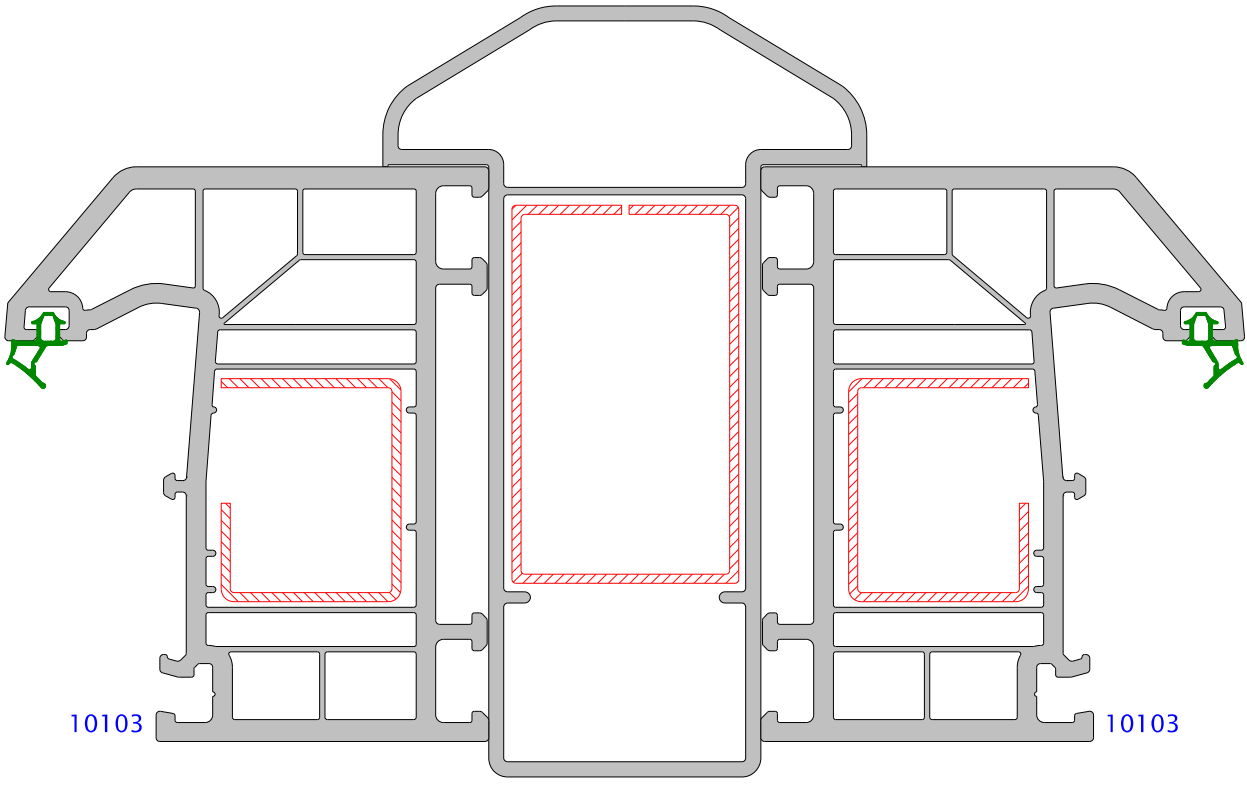

10103

12354

10103

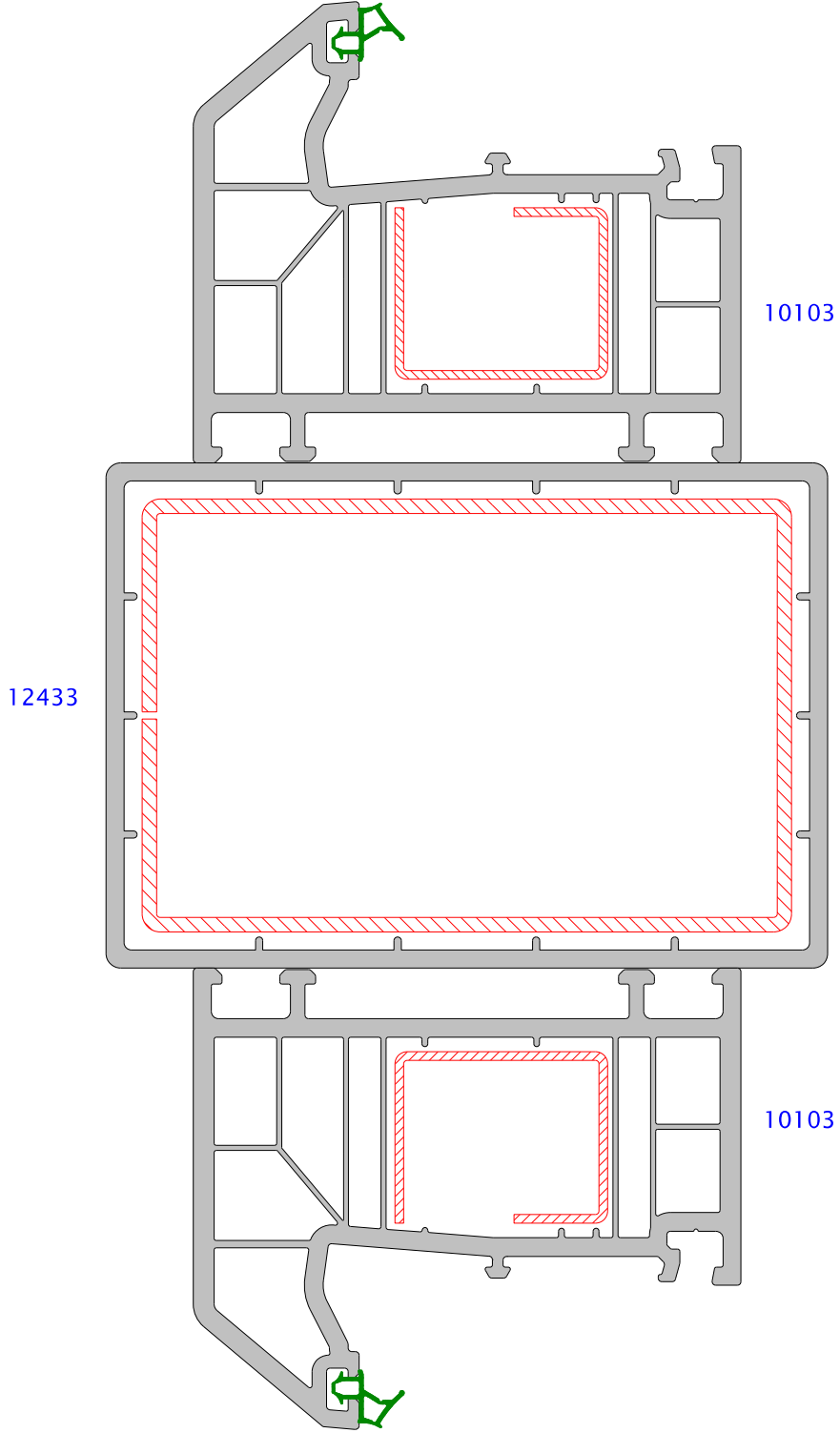

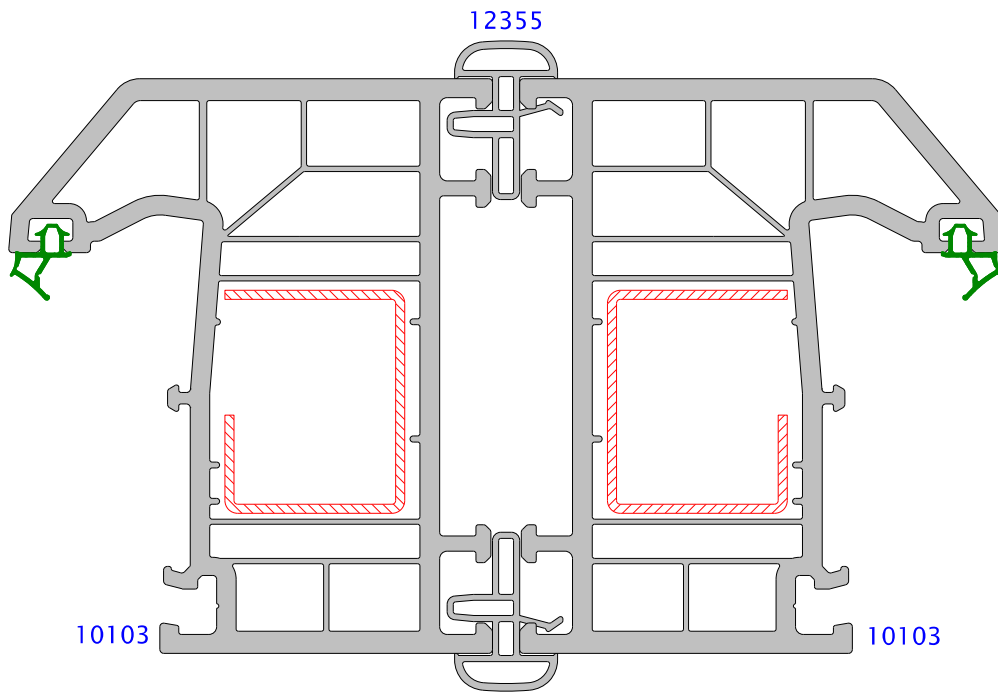
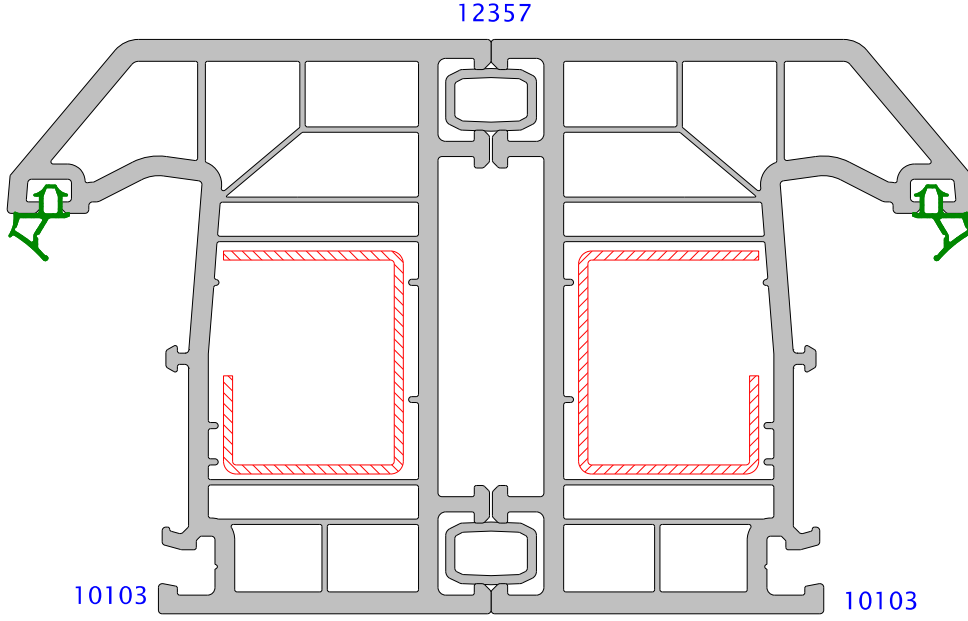
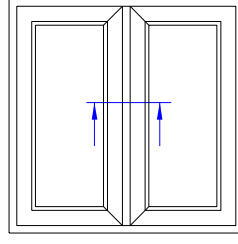

10123

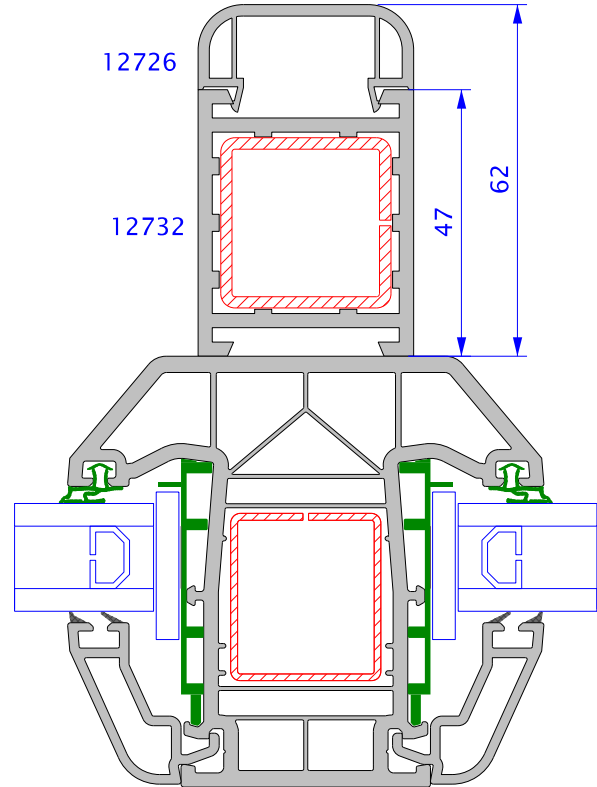
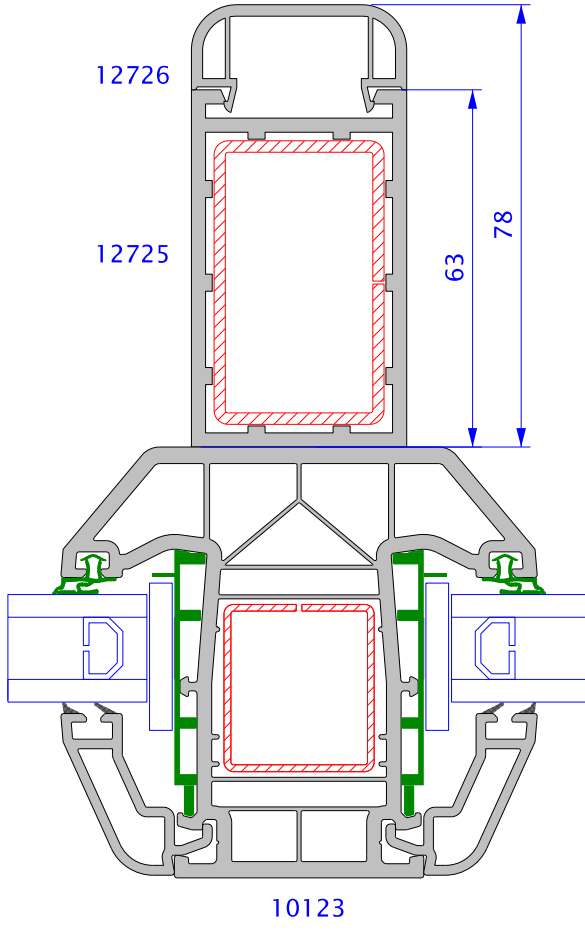

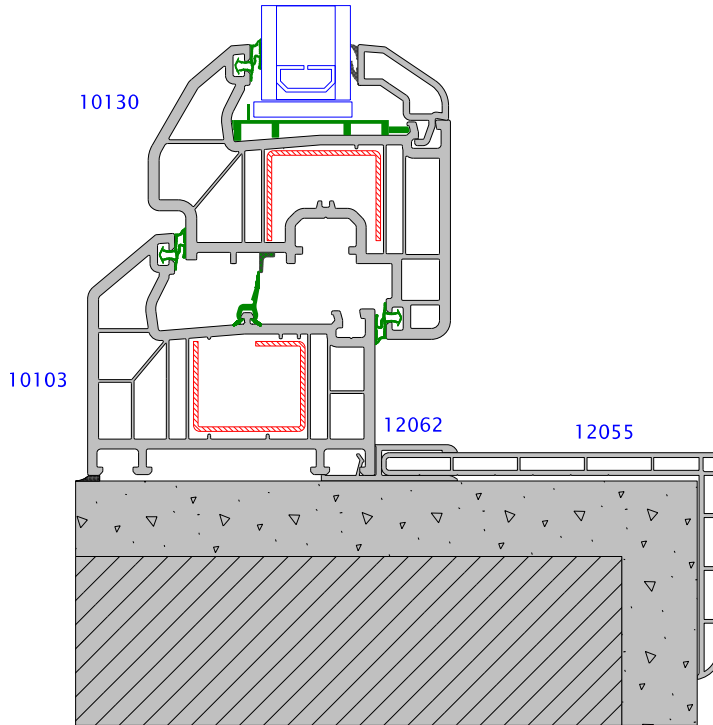
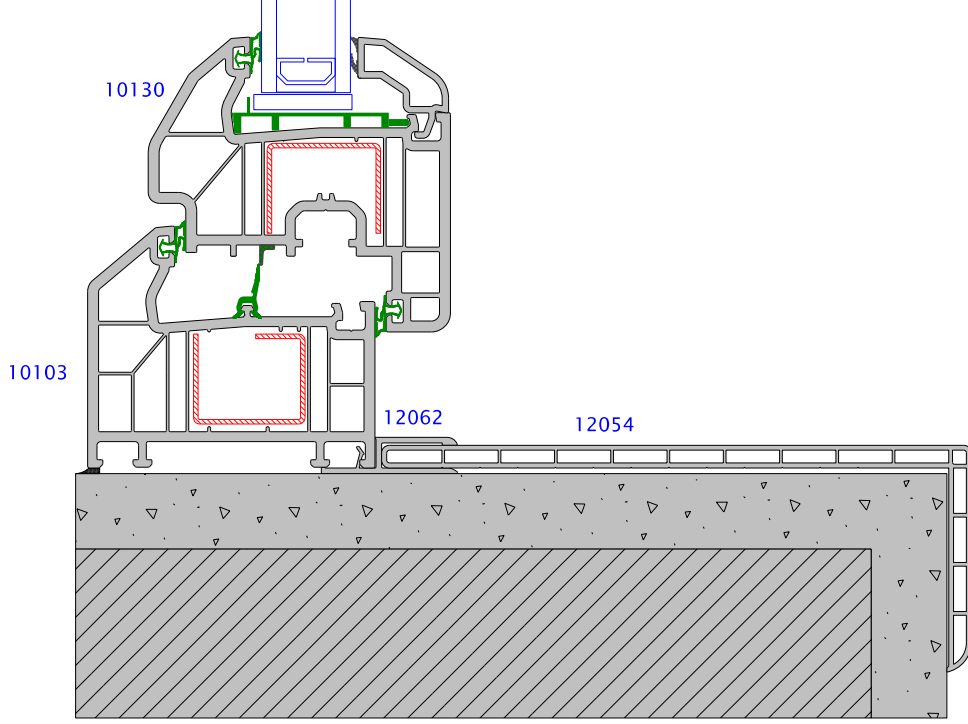
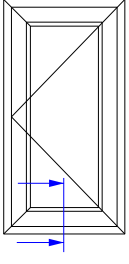

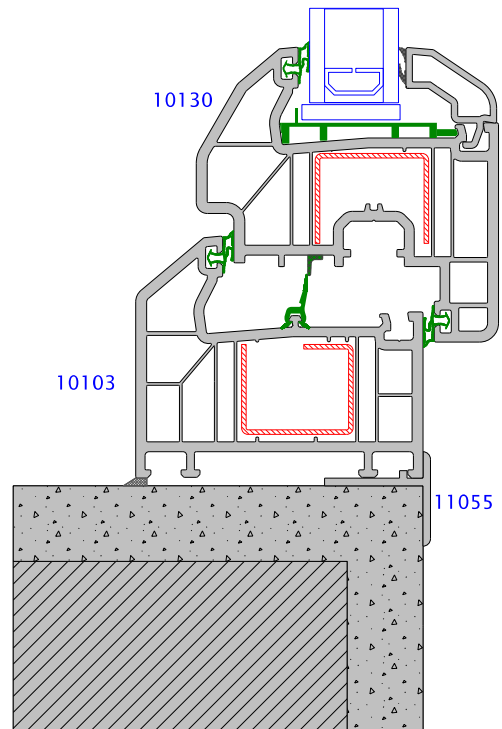
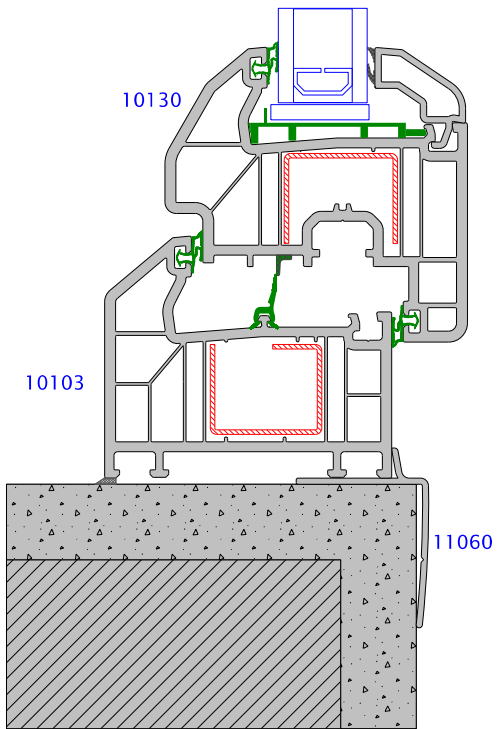
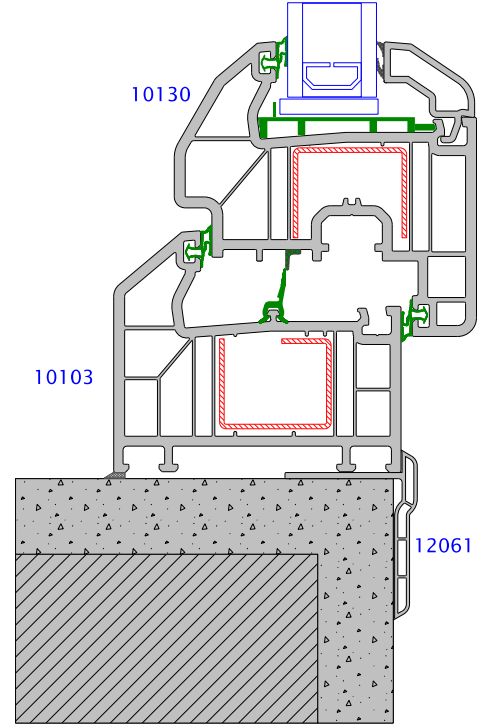
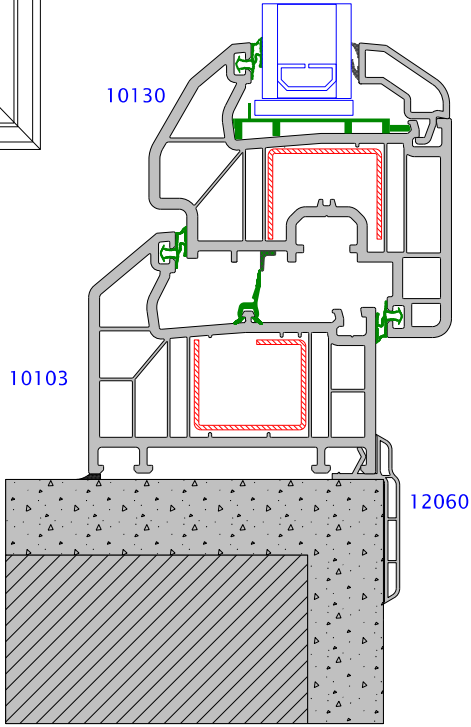
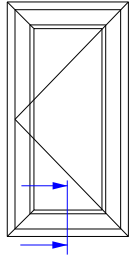

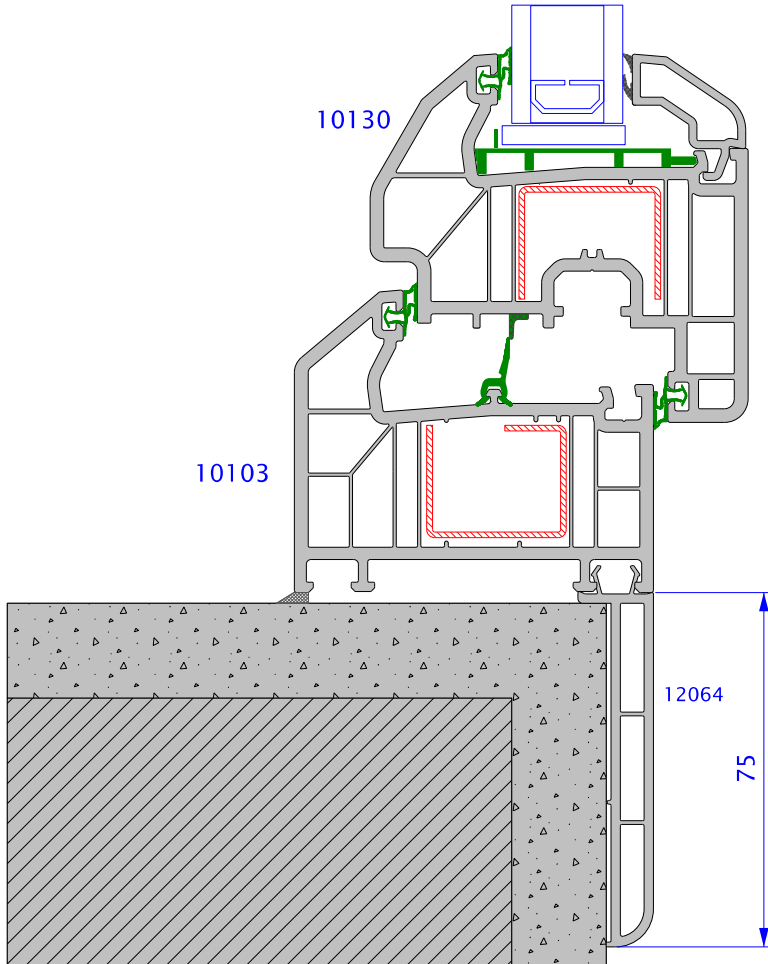
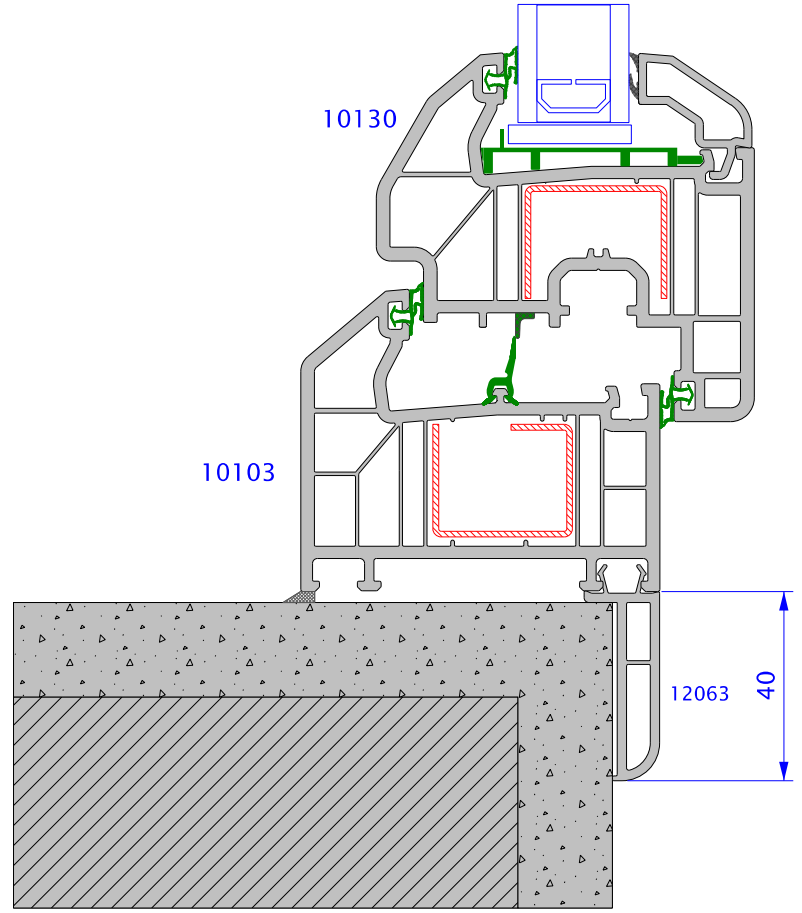
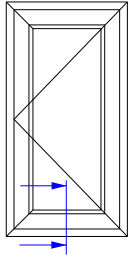

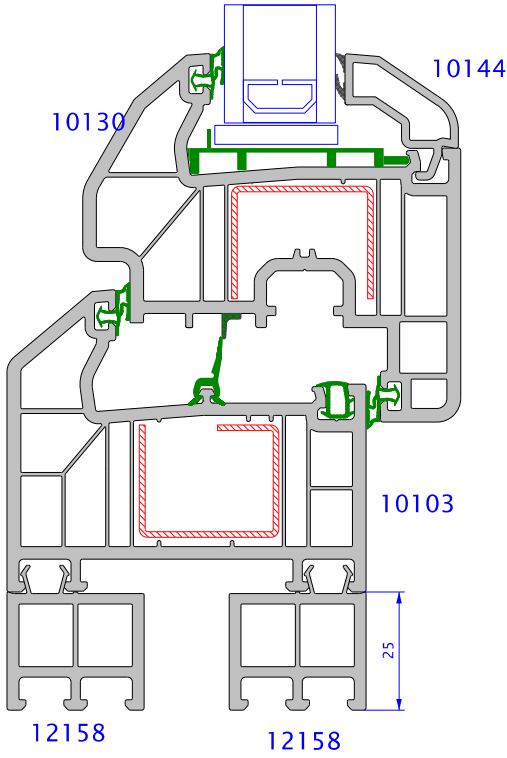
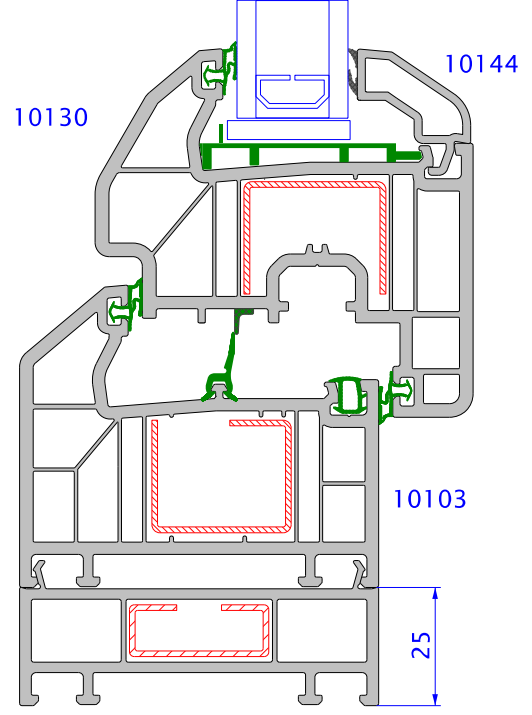
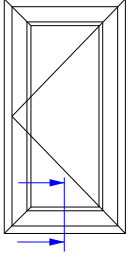

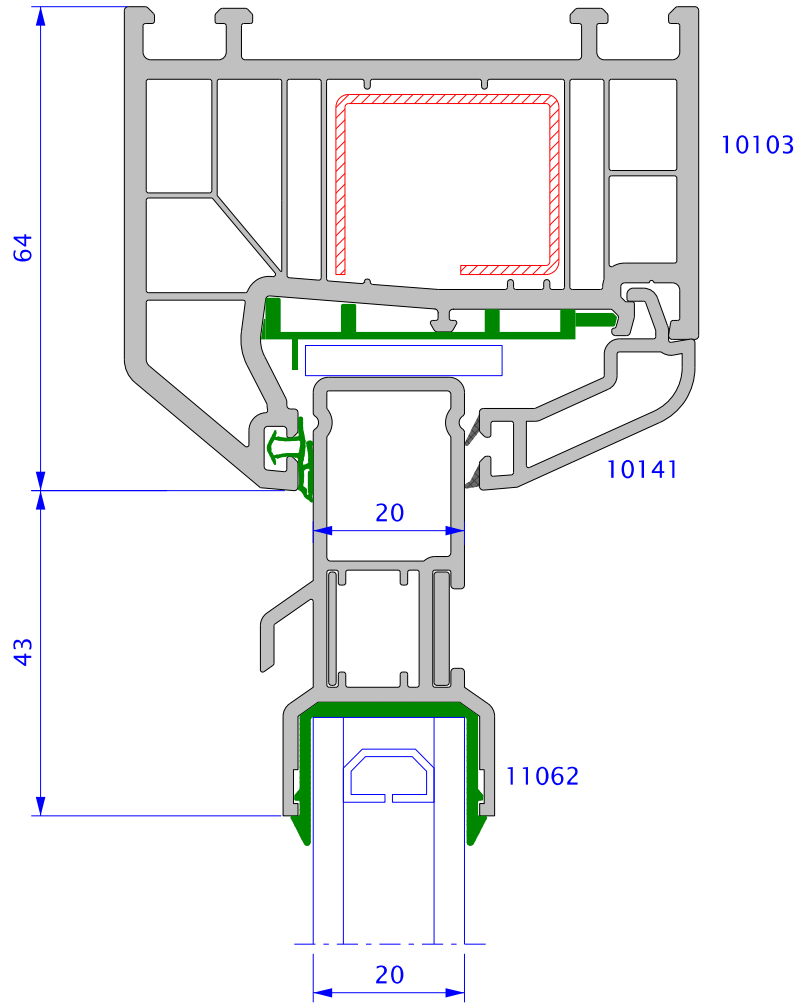
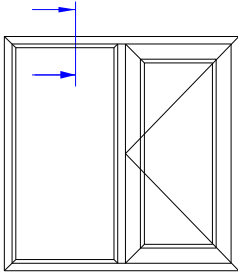

winsa[®]

www.winsa.com.tr